



Booster Circulation Pump



AQUASTRONG Co.,Ltd

Add: Via Bramante 3520154 Milano Italy
Tel: +39 0294 7591 77
Fax: +39 0294 7591 77
www.aquastrong.it
E-mail: info@aquastrong.it

CE ISO 9001

AQUASTRONG Co.,Ltd

About us

AQUASTRONG was established in 1990s as a global water pumps provider based in Italy, develops and sells pumps for house, garden, agriculture and commercial applications.

Nowadays **AQUASTRONG**'s strategy enables it to supply best price/performance ratio pumps with the process of controlling and monitoring quality starting from R&D, throughout manufacturing, marketing, sales, and after sales service.

As a trusted name that is highly appreciated by customers to serve their needs better than similar products available in the market, and is recognized for transparency in business relationship.

Our mission

To be recognized pump brand that offers clients a comprehensive range of high quality pumps of international standards and that suits the needs of customers in the world, and support these products with an after sales service according to our warranty policy.

Our values

The core values of **AQUASTRONG** stem from the credibility of its products and relations with its clients. This credibility is evident in the careful control of product's standard, reliability, warranty and development. It also embraces our commitment of transparency and honesty in dealing with all stakeholders.

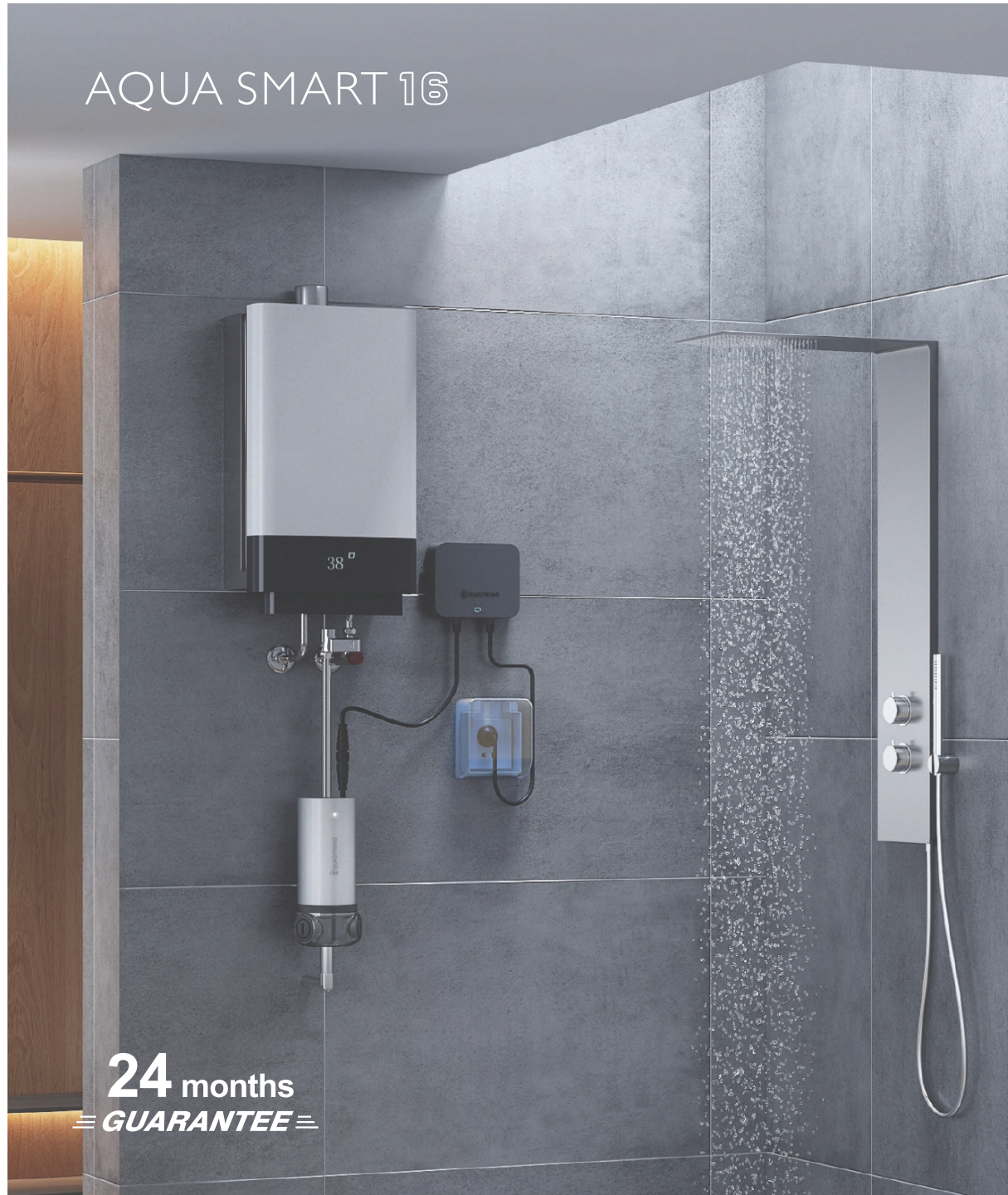

AQUA SMART 16

24 months
GUARANTEE

Applications

It could be used to the water pressure boosting of the electric water heater, solar water heater, gas water heater, shower head, faucet, washing machine, etc.

Working Conditions

Model:	AQUA SMART 16	AQUA SMART 16E
Voltage :	DC24V	DC24V
Max power	96W	96W
Rated power :	84W	84W
Max current	4A	4A
Rated current:	3.5A	3.5A
Max speed of rotation:	1,500~10,000r/min	1,500~10,000r/min
Max.head /	16m	14m
Rated head:	10m	9m
Max.flow:	1.5m³/h	1.3m³/h
Max.suction head:	None	None
Max.liquid temperature:	90 C	60 C
Max.ambient temperature:	55 C	55 C
Max.system pressure:	10bar (145PSI , 1MPa)	10bar (145PSI , 1MPa)
Protection level :	IP57	IP57
Type of used liquid:	Clean water	Clean water
Insulation class:	F	F

PERFORMANCE RANGE

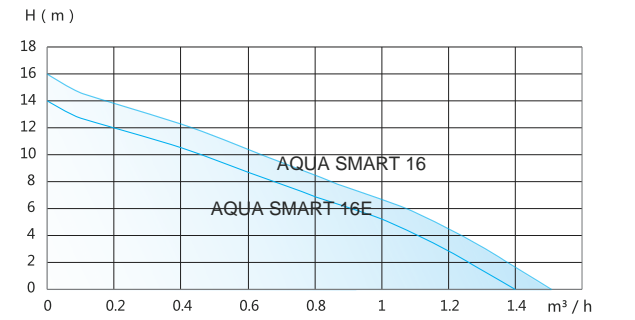

DIMENSION DIAGRAM

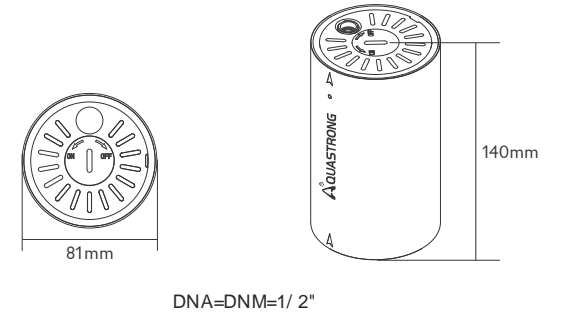

Model:	Inner Carton Dimension	Master Carton Dimension	G.W:	PCS/ Carton
AQUA SMART 16	315.5 x 249 x 125 mm	508 x 323 x 396 mm	16.8 kg	6
AQUA SMART 16E				8

Application Scenario

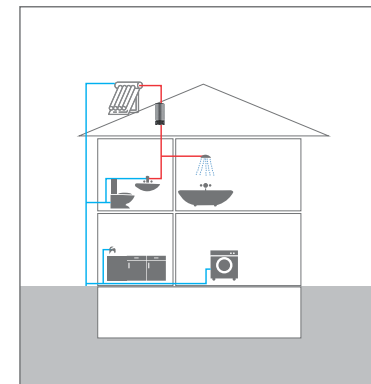

Solar water heater boosting

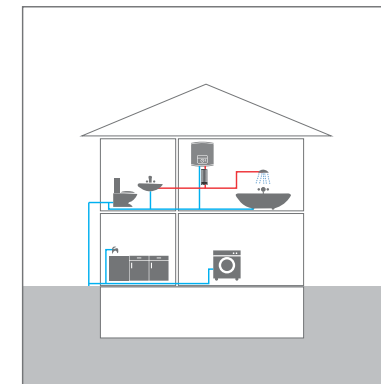

Water heater boosting



Application

- It is widely used for heating ventilating and air conditioning (HVAC) circulation, pressure boosting of hot water in family,homes powered by solar energy,industrial auxiliary equipment cold and hot water circulation and so forth
- Water circulation for the central and district heating system
- Domestic hot water circulation

Pump

- Broze or anti-rust cast iron pump body
- Noryl impeller with heat resistance up to 150 C
- 99% alumina ceramic shaft
- Liquid temperature: 2 ~ 110 C

Motor

- Insulation class: H
- Protection class: IP44
- 99% alumina ceramic bearing
- Copper winding
- Three speed motor

Identification Codes

ERP 15 - 50 F / 130

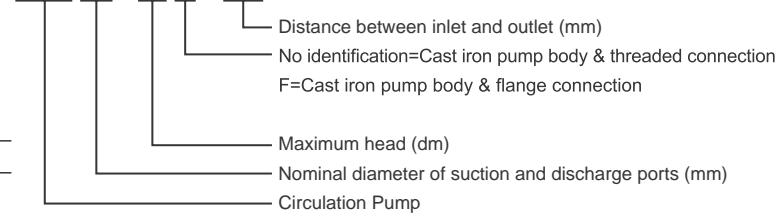

Connectors on request

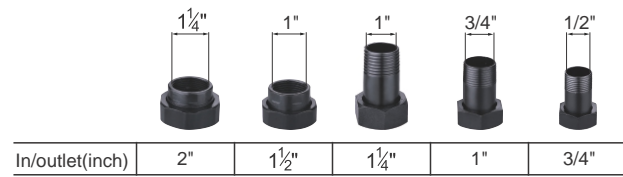

In/outlet(inch)	2"	1 1/2"	1 1/4"	1"	3/4"
-----------------	----	--------	--------	----	------

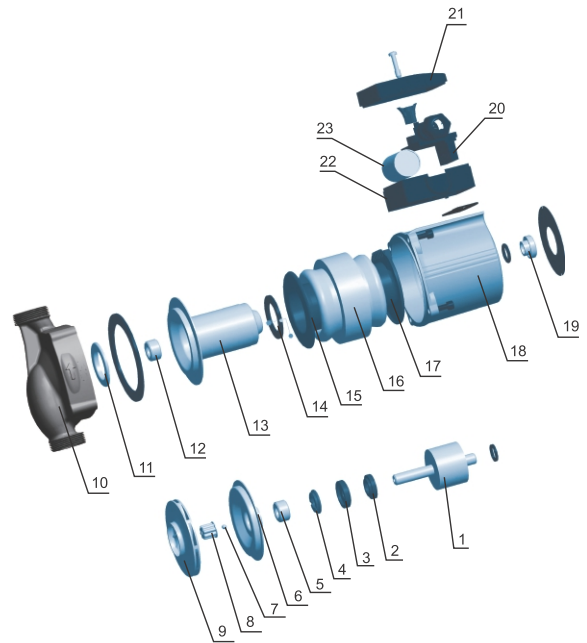

Materials Table

No.	Part	Material
1	Rotor	
2	Thrust bearing adjusting mat	Noryl
3	Thrust ring support	Silicon rubber
4	Bushings	Graphite
5	Front bearing	Alumina
6	Pump support cover	Stainless steel
7	Check ball	Silicon rubber
8	Locking	Stainless steel
9	Impeller	PPO
10	Pump body	Cast iron/Bronze
11	Pump body insert	Stainless steel
12	Back bearing	Alumina
13	Can brg asm	Stainless steel
14	Can brg asm seal	Silicon rubber
15	Stator cover(front)	PA66
16	Stator	
17	Stator cover(back)	PA66
18	Housing	ADC12
19	Drain plug	Copper
20	Speed regulation board	
21	Terminal cover	ABS
22	Terminal box	PC
23	Capacitor	

Dimension Drawing

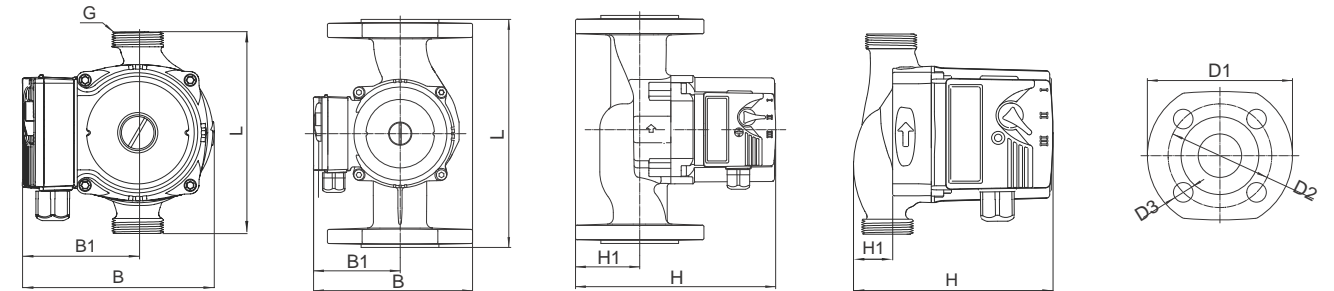

Model	L (mm)	B (mm)	B1 (mm)	H (mm)	H1 (mm)	G
ERP15-40/130	130	125	75	130	25	G1
ERP20-40/130	130	125	75	130	25	G1.25
ERP25-40/130	130	125	75	130	25	G1.5
ERP25-40/180	180	125	75	130	25	G1.5
ERP32-40/180	180	125	75	135	30	G2
ERP15-50/130	130	125	75	130	25	G1
ERP20-50/130	130	125	75	130	25	G1.25
ERP25-50/130	130	125	75	130	25	G1.5
ERP25-50/180	180	125	75	130	25	G1.5
ERP32-50/180	180	125	75	135	30	G2
ERP15-60/130	130	125	75	130	25	G1

Model	L (mm)	B (mm)	B1 (mm)	H (mm)	H1 (mm)	G
ERP20-60/130	130	125	75	130	25	G1.25
ERP25-60/130	130	125	75	130	25	G1.5
ERP25-60/180	180	125	75	130	25	G1.5
ERP32-60/180	180	125	75	135	30	G2

Model	L (mm)	B (mm)	B1 (mm)	H (mm)	H1 (mm)	D1 (mm)	D2 (mm)	D3 (mm)
ERP32-80F/220	220	150	85	191.5	65	140	Φ100	Φ19
ERP36-80F/200	200	138	85	174.5	45	90	Φ90	Φ11.5
ERP40-80F/250	250	155	85	196.5	70	150	Φ110	Φ19

Technical Data

Model	Voltage /Frequency (V/Hz)	Power(W)			Max. Flow (l/min)	Max.Head (m)	N.W. (kgs)	G.W. (kgs)	Packing Size (mm)
		3	2	1					
ERP15-40/130	220~240/50Hz	67	58	40	46/42/30	4.5/4.4/3.6	2.32	2.45	165x150x140
ERP20-40/130	220~240/50Hz	68	59	40	51/46/32	4.3/4.1/3.6	2.37	2.5	165x150x140
ERP25-40/130	220~240/50Hz	72	63	42	60/55/33	4.6/3.3/2.3	2.44	2.57	165x150x140
ERP25-40/180	220~240/50Hz	73	64	43	64/58/35	4.6/4.3/3.9	2.55	2.71	195x150x140
ERP32-40/180	220~240/50Hz	69	60	41	60/54/37	4.3/4.0/3.4	2.73	2.89	195x150x140
ERP15-50/130	220~240/50Hz	85	60	40	40/32/23	4.5/3.8/2.5	2.32	2.45	165x150x140
ERP20-50/130	220~240/50Hz	75	65	42	50/43/28	5.2/4.9/3.4	2.37	2.5	165x150x140
ERP25-50/130	220~240/50Hz	73	62	41	60/52/33	5.3/5.0/3.6	2.44	2.57	165x150x140
ERP25-50/180	220~240/50Hz	75	66	43	63/53/35	5.2/4.9/3.2	2.55	2.71	195x150x140
ERP32-50/180	220~240/50Hz	73	65	42	63/54/35	5.2/4.9/3.7	2.73	2.89	195x150x140
ERP15-60/130	220~240/50Hz	85	71	44	48/42/28	6.0/5.8/4.2	2.32	2.45	165x150x140
ERP20-60/130	220~240/50Hz	96	69	45	53/37/25	5.5/4.5/2.8	2.37	2.5	165x150x140
ERP25-60/130	220~240/50Hz	83	70	43	58/43/28	5.5/4.5/2.8	2.44	2.57	165x150x140
ERP25-60/180	220~240/50Hz	83	69	44	68/60/35	6.1/5.8/4.5	2.55	2.71	195x150x140
ERP32-60/180	220~240/50Hz	85	77	44	66/58/38	5.9/5.5/4.1	2.73	2.89	195x150x140
ERP32-80F/220	220~240/50Hz	270	245	160	170/113/65	7.3/6.7/5.4	7.57	8	235x181x207
ERP36-80F/200	220~240/50Hz	270	245	160	170/113/65	7.3/6.7/5.4	5.98	6.36	214x170x190
ERP40-80F/250	220~240/50Hz	270	245	160	170/113/65	7.3/6.7/5.4	8.27	8.74	264x186x212

Performance Curves

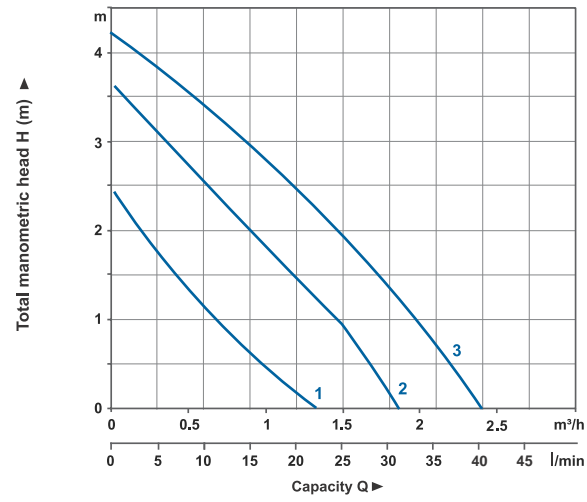

ERP15-40

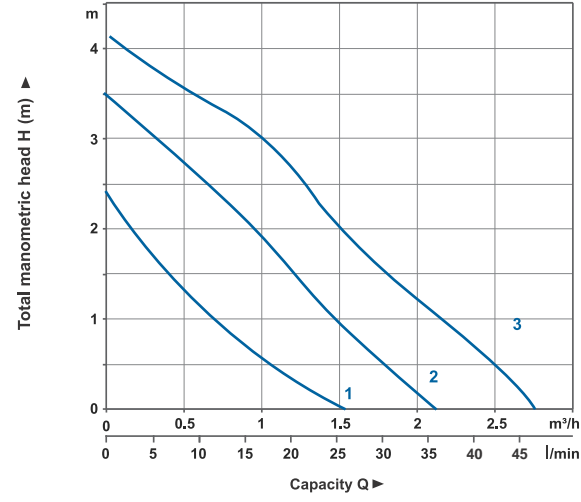

ERP20-40

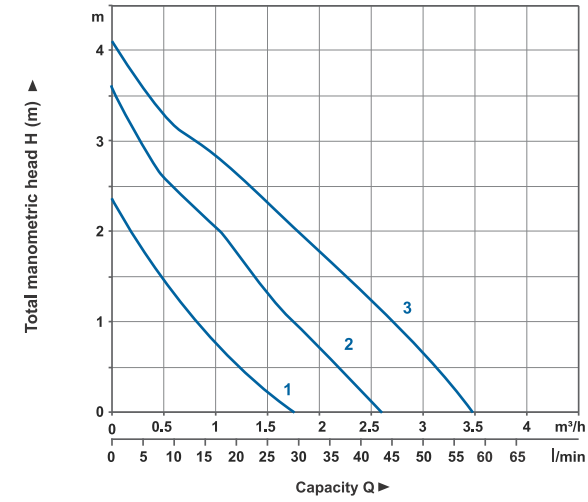

ERP32-40

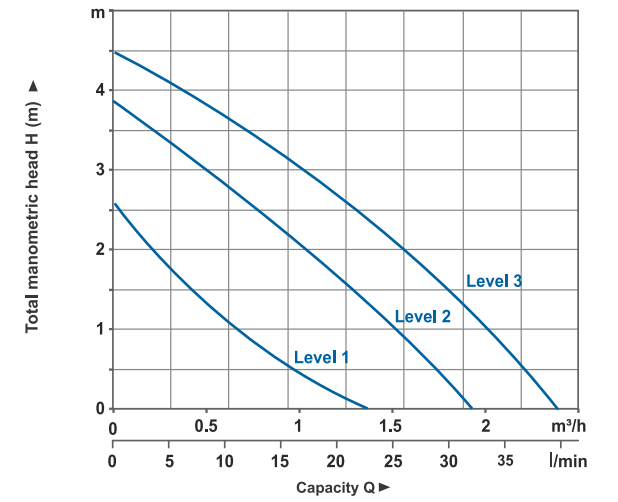

ERP15-50

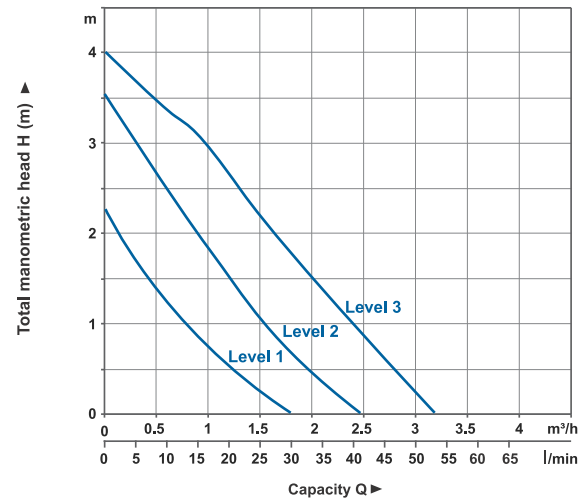

ERP25-40

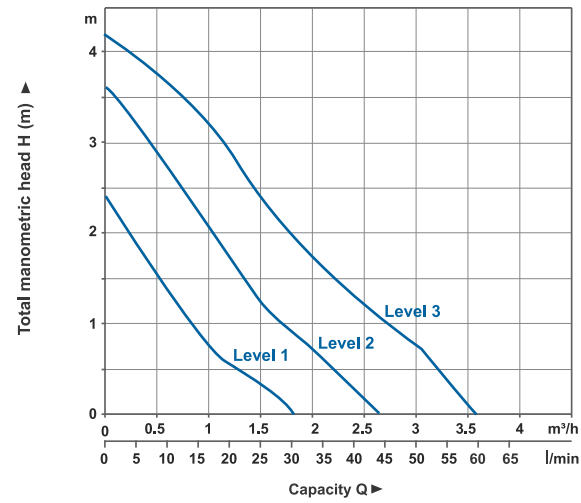

ERP25-40/180

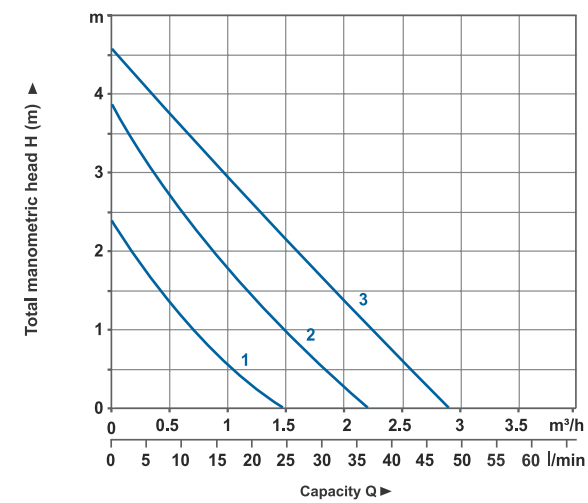

ERP20-50

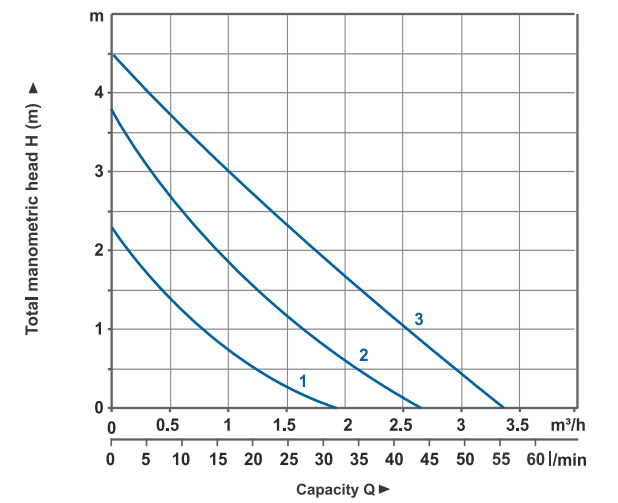

ERP25-50

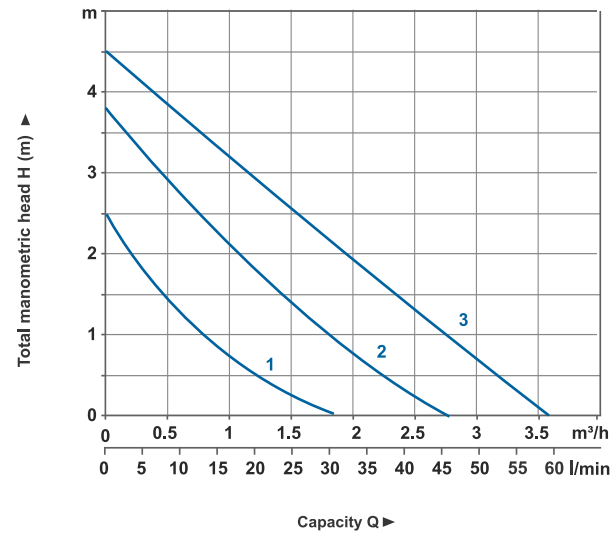

ERP25-50

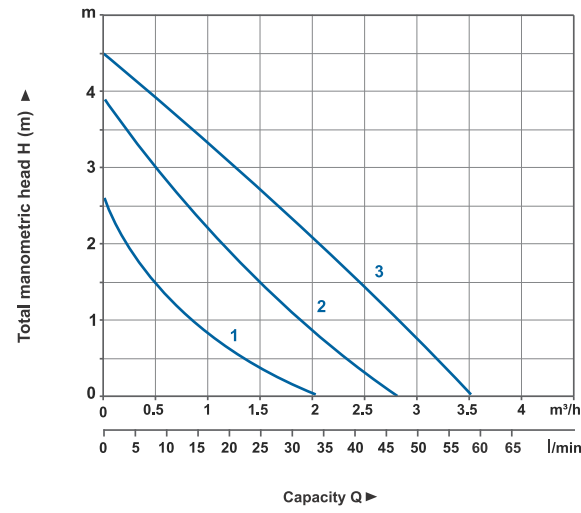

ERP32-50

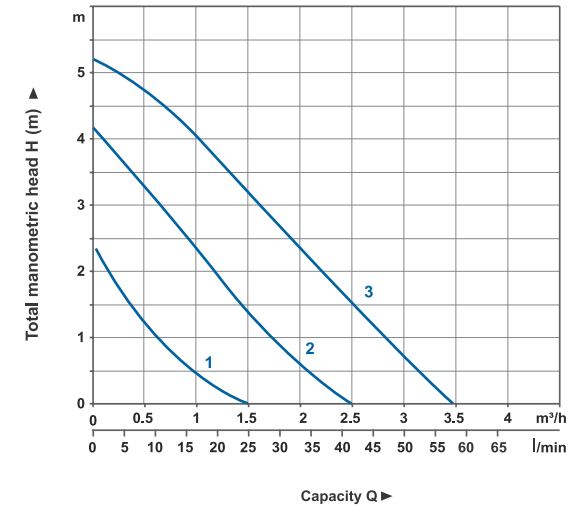

ERP25-60

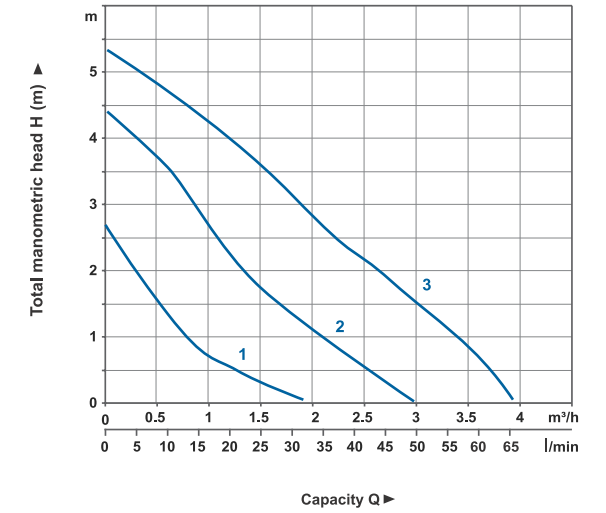

ERP25-60

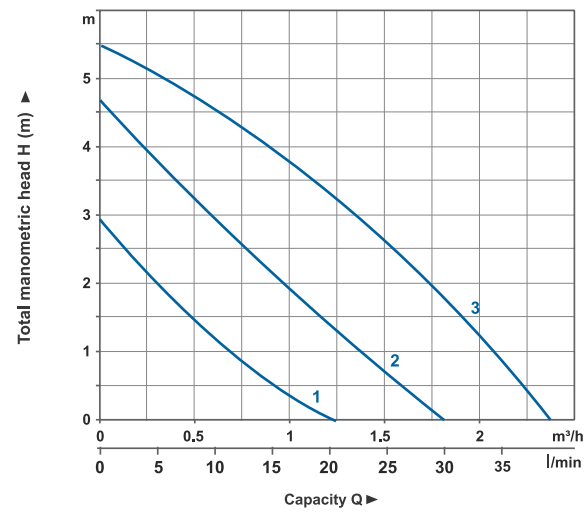

ERP15-60

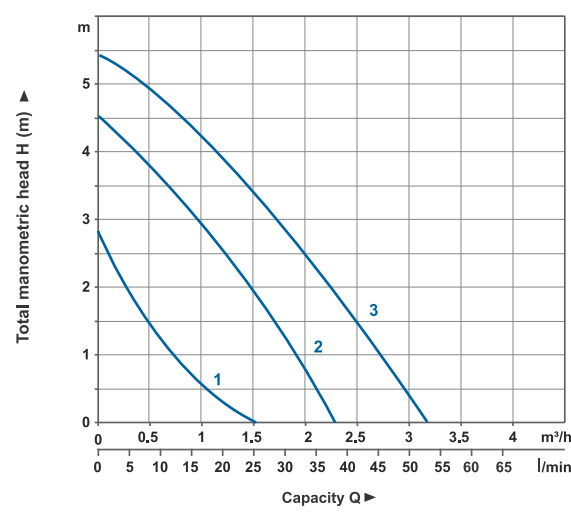

ERP20-60

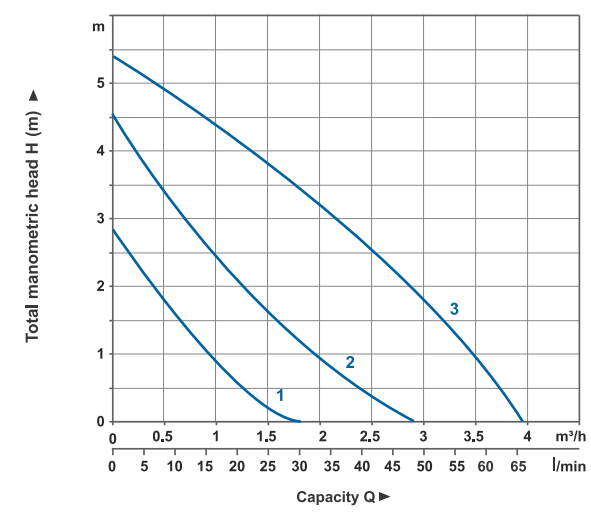

ERP32-60

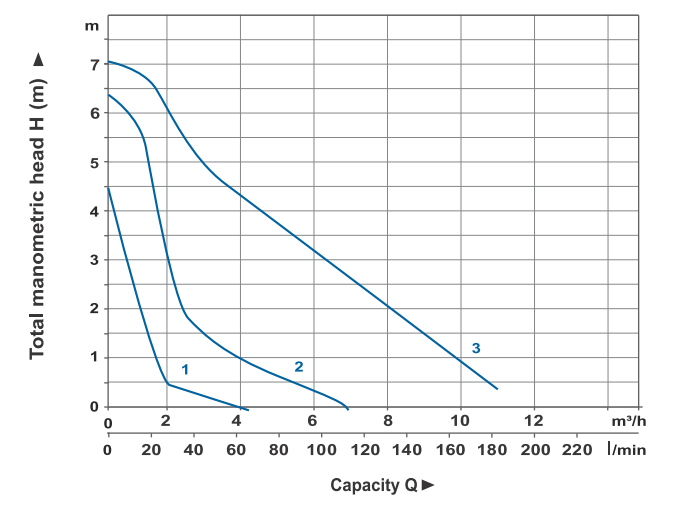

ERP40-80F



Application

- It is widely used for heating ventilating and air conditioning (HVAC) circulation, pressure boosting of hot water in family,homes powered by solar energy,industrial auxiliary equipment cold and hot water circulation and so forth
- Water circulation for the central and district heating system
- Domestic hot water circulation

Pump

- Anti-rust cast iron pump body
- Noryl impeller with heat resistance up to 150 C
- 99% alumina ceramic shaft
- Liquid temperature: 2 ~ 110 C

Motor

- Insulation class: H
- Protection class: IP44
- 99% alumina ceramic bearing
- Copper winding
- Three speed motor

Identification Codes

ERP 20 - 50 / 130

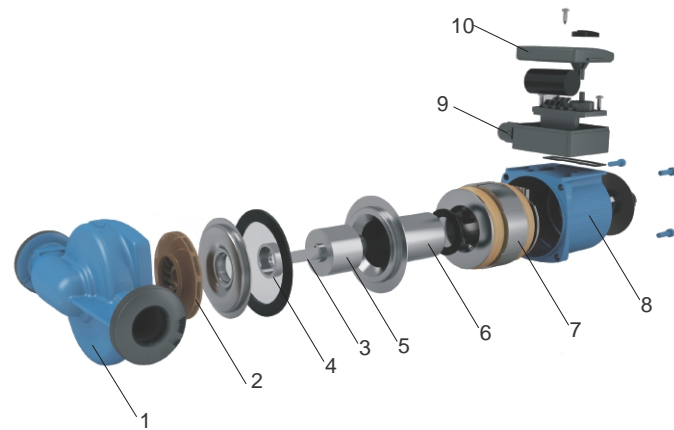
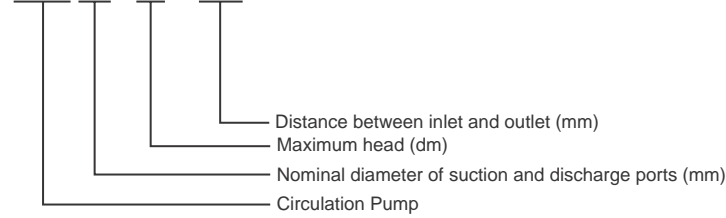

Materials Table

No.	Part	Material
1	Pump housing	Cast iron
2	Impeller	Engineering plastic
3	Shaft	Ceramic/ Stainless steel
4	Bearing base	Stainless steel
5	Rotor	
6	Can brg asm	Stainless steel
7	Stator sleeve	
8	Housing	ADC12
9	Terminal box	ABS
10	Terminal cover	ABS

Dimension Drawing

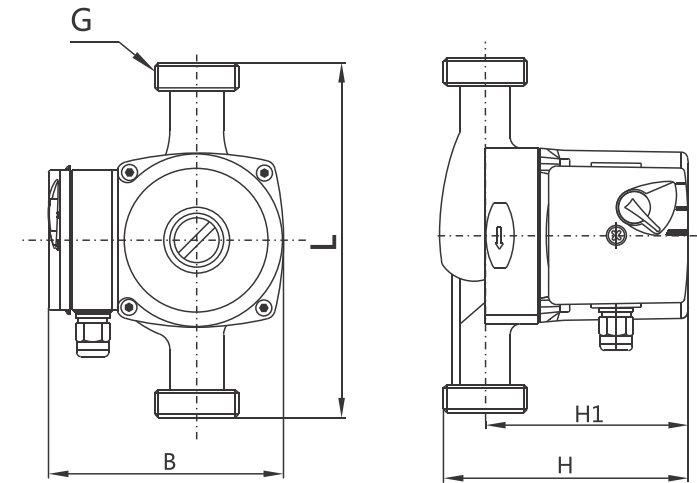

Model	Dimension					Weight(Kg)		Connection/Flange	Package size (mmxmmxmm)	
	L	H	H1	B	G	N.W.	G.W.		Inner box	Out box
ERP20-70/130	130	130	105	130	1"	2.3	2.7	1"-3/4"	170×140×145	350×290×300
ERP25-70/130	130	130	105	130	1 1/2"	2.6	3.2	1 1/2" - 1"	170×140×145	350×290×300
ERP25-70/180	180	130	105	130	1 1/2"	2.6	3.2	1 1/2" - 1"	200×140×145	410×290×300
ERP32-70/180	180	130	105	130	2"	2.9	3.8	2"-1 1/4" or 1 1/2"	200×140×145	410×290×300
ERP25-80/180	180	170	130	150	1 1/2"	4.8	5.5	1 1/2" - 1"	200×165×190	410×340×195
ERP32-80/180	180	170	130	150	2"	4.6	5.6	2"- 1 1/4" or 1 1/2"	200×165×190	410×340×195
ERP15-90/130	130	130	105	130	3/4"	2.3	2.5	3/4" - 1/2"	170×140×145	350×290×300
ERP15-120/150	150	150	132	150	3/4"	3.9	4.4	3/4" - 1/2"	200×165×190	410×340×195
ERP25-120/180	180	151	128	150	1 1/2"	2.3	2.5	1 1/2" - 1"	200×165×190	410×340×195

Technical data

Model	Max. Flow (m³/h)			Max. Head (m)			Rated Power (W)			Rated Current (A)			Voltage(V)/ Frequency
ERP20-70/130	3.5	2.25	1.8	6.5	5	2.5	130	110	90	0.6	0.52	0.42	220-240V/50Hz
ERP25-70/130	4.0	2.7	1.7	6.5	5.5	3							
ERP25-70/180	4.0	2.7	1.7	6.5	5.5	3							
ERP32-70/180	4.5	3.5	2.5	6.5	7.5	4.5	245	190	135	1.1	0.85	0.6	
ERP25-80/180	6	5	3.5	8	7.5	5.5							
ERP32-80/180	8	5	3.5	8	7.5	5							
ERP15-90/130	1.8	1.1	0.6	9	7.5	4	120	80	50	0.53	0.4	0.25	
ERP15-120/150	3.5	2.5	1.5	12	10	8	270	240	160	1.2	1.1	0.75	
ERP25-12/180	4	2	1.5	12	10	6	270	240	160	1.2	1.1	0.75	

Performance Curves

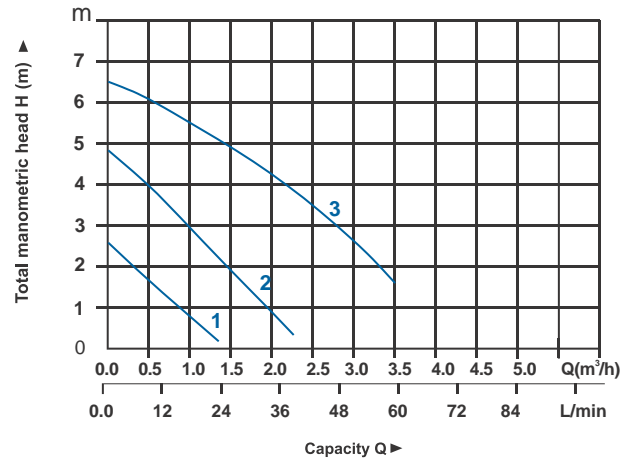

ERP20-70

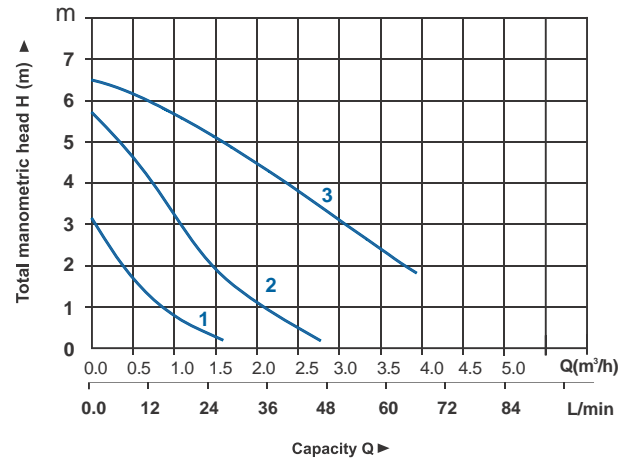

ERP25-70

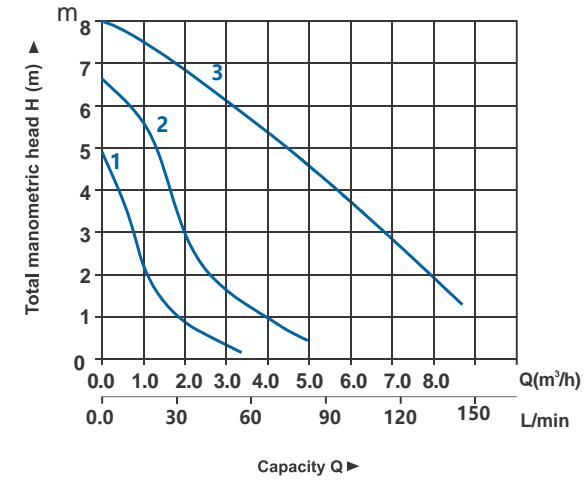

ERP32-80

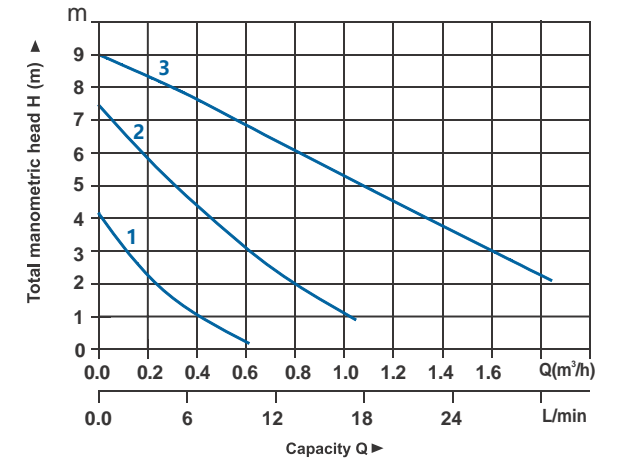

ERP15-90

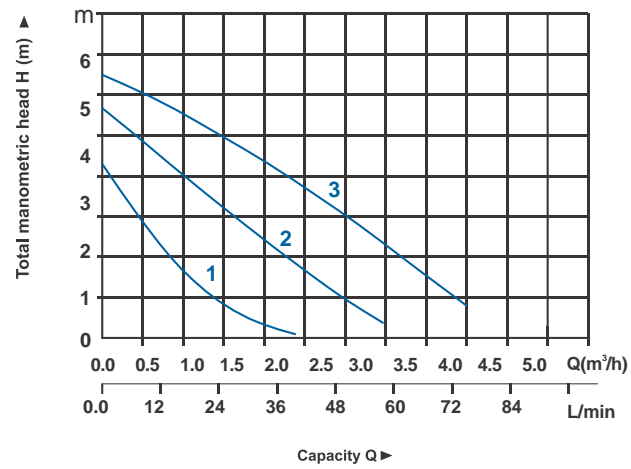

ERP32-70

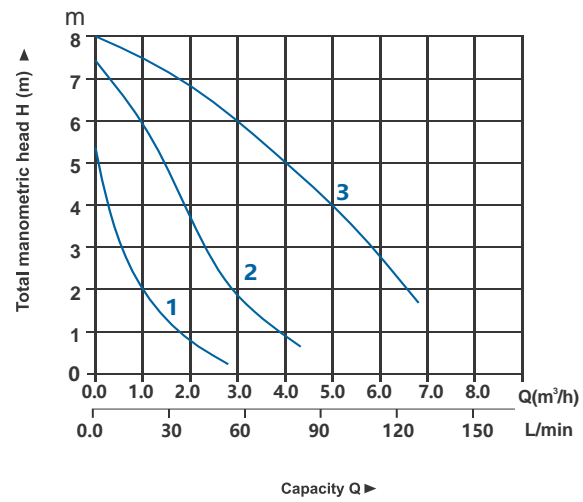

ERP25-80

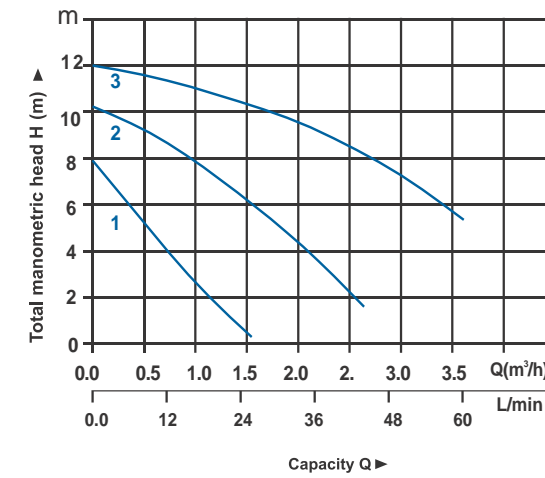

ERP15-120

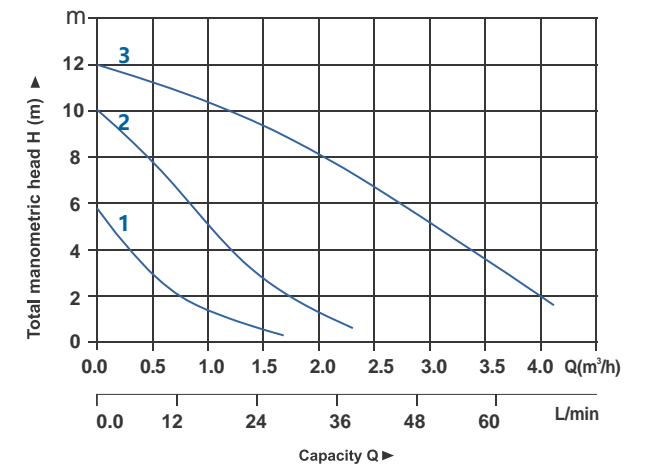

ERP25-120

Application

- It is widely used for heating ventilating and air conditioning (HVAC) circulation, pressure boosting of hot water in family,homes powered by solar energy,industrial auxiliary equipment cold and hot water circulation and so forth
- Water circulation for the central and district heating system
- Domestic hot water circulation

Pump

- Anti-rust cast iron pump body
- Noryl impeller with heat resistance up to 150 C
- 99% alumina ceramic shaft
- Liquid temperature: 2 ~ 110 C

Motor

- Insulation class: H
- Protection class: IP44
- 99% alumina ceramic bearing
- Copper winding



Identification Codes

ERP 32 - 90 F / 220

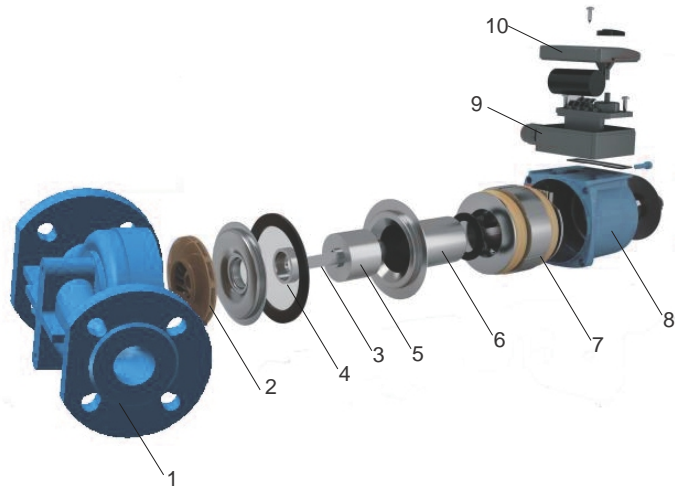
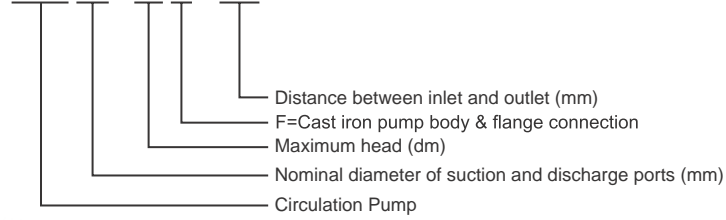

Materials Table

No.	Part	Material
1	Pump housing	Cast iron
2	Impeller	Engineering plastic
3	Shaft	Ceramic/ Stainless steel
4	Bearing base	Stainless steel
5	Rotor	
6	Can brg asm	Stainless steel
7	Stator sleeve	
8	Housing	ADC12
9	Terminal box	ABS
10	Terminal cover	ABS

Dimension Drawing

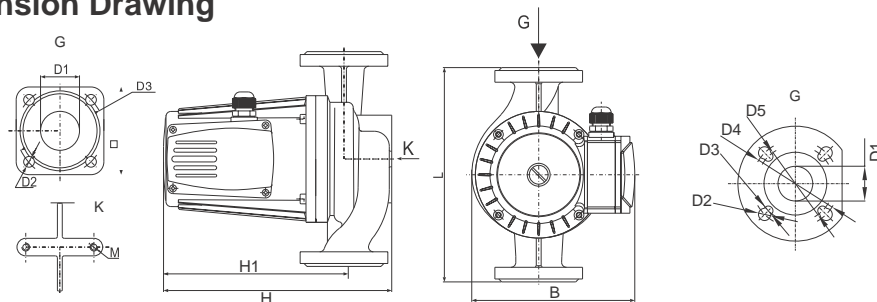

Model	Dimension											Weight (Kg)		Connection /Flange	Package size (mmxmmxmm)	
	L	H	H1	B	D1	D2	D3	D4	D5	D6	M	N.W.	G.W.		Inner box	Out box
ERP32-90F/220	220	214	165	167	40	11.5	90	/	/	/	M8	8	9.7	DN32	255x200x235	520x410x240
ERP32-120F/220	220	234	185	167	40	11.5	90	/	/	/	M8	9.3	10.9	DN32	255x200x255	520x410x260
ERP40-45F/230	230	250	189	167	40	13.5	100	130	100	150	M8	9.5	12.2	DN40	255x190x270	265x390x275
ERP40-60F/230	230	270	209	167	40	13.5	100	130	100	150	M8	10.8	13.5	DN40	200x140x145	265x390x295
ERP40-120F/250	250	297	232	234	40	17.5	13.5	110	100	150	M10	15.3	18.4	DN40	/	260x260x330
ERP40-160F/250	250	297	232	234	40	17.5	13.5	110	100	150	M10	16.9	20	DN40	/	260x260x330
ERP50-50F/250	250	237	165	222	50	17.5	13.5	125	110	165	M10	11.6	13	DN50	/	310x200x280
ERP50-580F/250	250	237	185	222	50	17.5	13.5	125	110	165	M10	13	15	DN50	/	310x200x280
ERP50-120F/280	280	304	232	242	50	17.5	13.5	125	110	165	M10	17.6	22.4	DN50	/	393x338x293
ERP50-160F/280	280	329	257	242	50	17.5	13.5	125	110	165	M10	19.6	24.4	DN50	/	393x338x293
ERP50-200F/280	280	329	157	242	50	17.5	13.5	125	110	165	M10	19.8	24.6	DN50	/	393x338x293
ERP65-50F/280	280	310	232	242	65	17.5	13.5	145	130	180	M10	18	21.5	DN65	/	393x338x293
ERP65-80F/280	280	310	232	242	65	17.5	13.5	145	130	180	M10	18.2	21.7	DN65	/	393x338x293
ERP65-100F/300	300	310	232	247	65	17.5	13.5	145	130	165	M10	19.7	24.7	DN65	/	393x358x293
ERP65-120F/300	300	335	257	247	65	17.5	13.5	145	130	165	M10	21.5	26.5	DN65	/	393x358x293

Technical Data

Model	Max. Flow (m³/h)	Rated head (m)	Rated Current (A)	Speed (r/min)	Voltage(V)/ Frequency
ERP32-90F/220	5	5	1.5	2750	220-240V/50Hz
ERP32-120F/220	5	8	2.5	2800	
ERP40-45F/230	8	3.2	1.5	2750	
ERP40-60F/230	12.5	4.5	2.5	2800	
ERP40-120F/250	8	10	3.4	2800	
ERP40-160F/250	8	15	4.9	2800	
ERP50-50F/250	9	2.5	1.5	2750	
ERP50-580F/250	12	4.5	2.5	2800	
ERP50-120F/280	12.5	9	4.9	2800	
ERP50-160F/280	12.5	12.5	5.8	2820	
ERP50-200F/280	12	14	5.8	2820	
ERP65-50F/280	15	3	3.4	2800	
ERP65-80F/280	20	5	3.4	2800	
ERP65-100F/300	18	7	4.9	2800	
ERP65-120F/300	25	7.5	5.8	2820	

Hydraulic Performance Curves

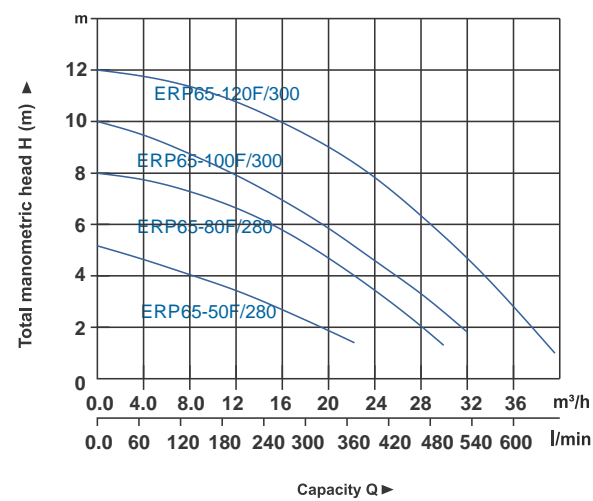
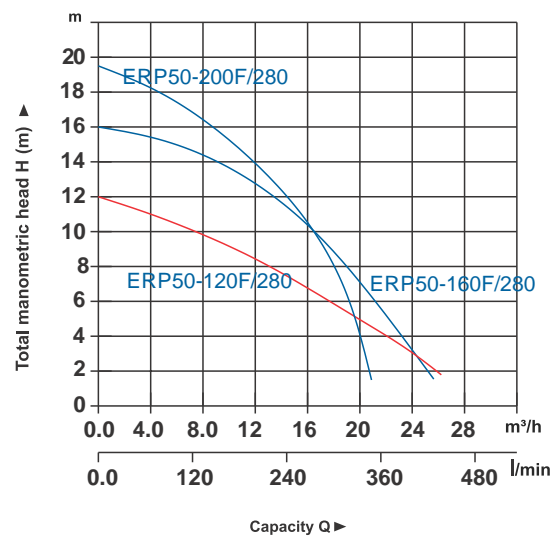
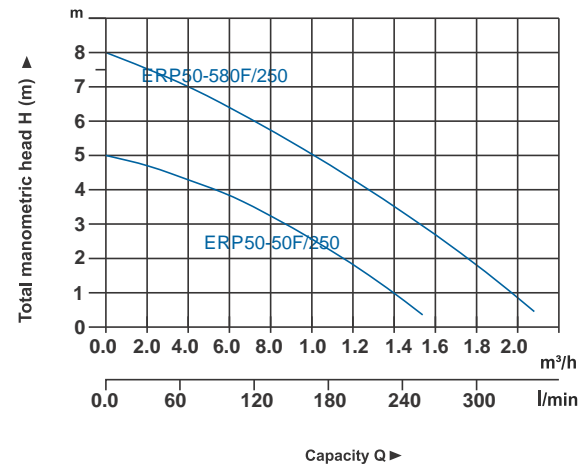
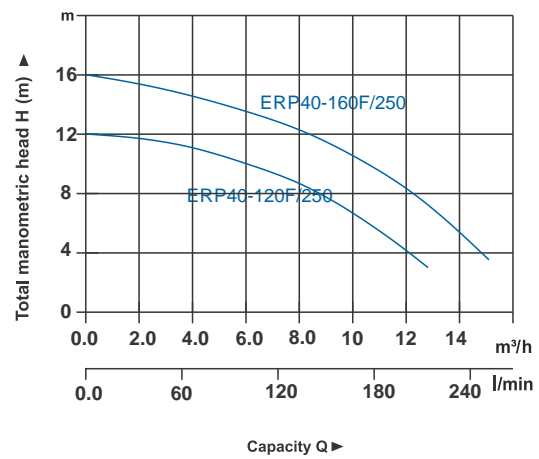
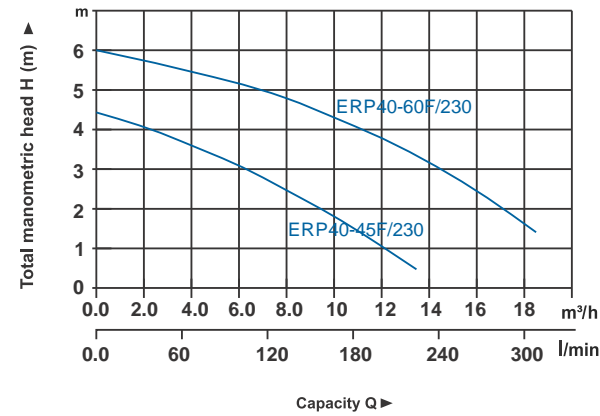
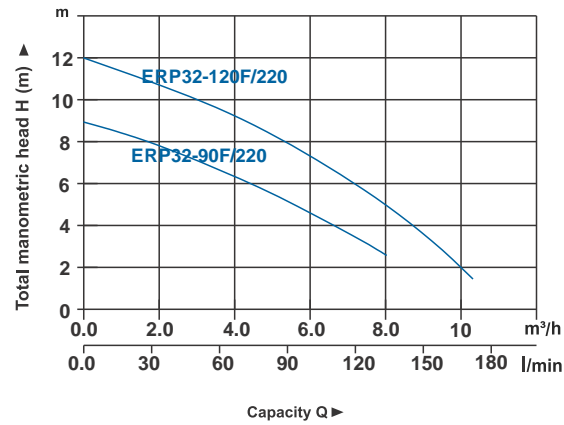

Application

- It is widely used for heating ventilating and air conditioning (HVAC) circulation, pressure boosting of hot water in family,homes powered by solar energy,industrial auxiliary equipment cold and hot water circulation and so forth
- Water circulation for the central and district heating system
- Domestic hot water circulation

Pump

- Broze pump body
- Noryl impeller with heat resistance up to 150 °C
- 99% alumina ceramic shaft
- Liquid temperature: 2 ~ 110 °C

Motor

- Insulation class: H
- Protection class: IP44
- 99% alumina ceramic bearing
- Copper winding
- Three speed motor



Identification Codes

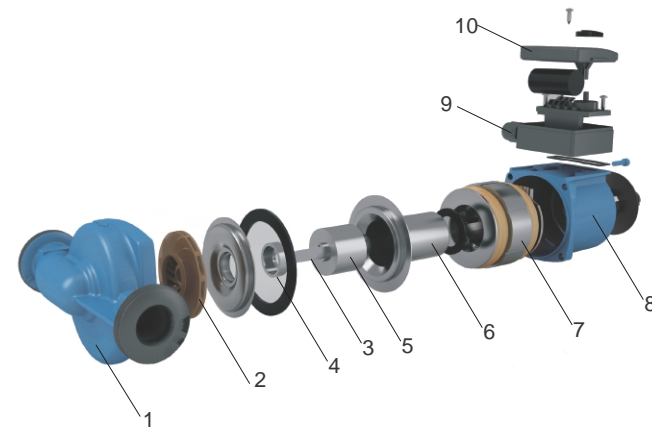
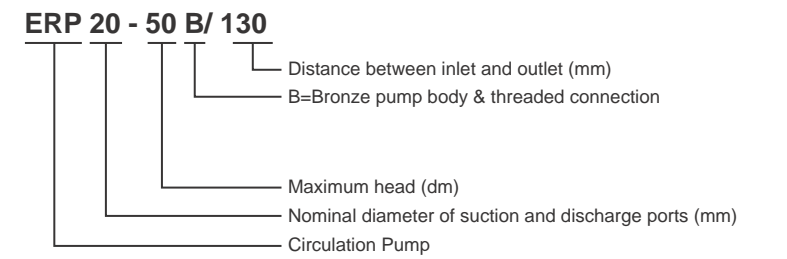

Materials Table

No.	Part	Material
1	Pump housing	Copper
2	Impeller	Engineering plastic
3	Shaft	Ceramic/ Stainless steel
4	Bearing base	Stainless steel
5	Rotor	
6	Can brg asm	Stainless steel
7	Stator sleeve	
8	Housing	ADC12
9	Terminal box	ABS
10	Terminal cover	ABS

Dimension Drawing

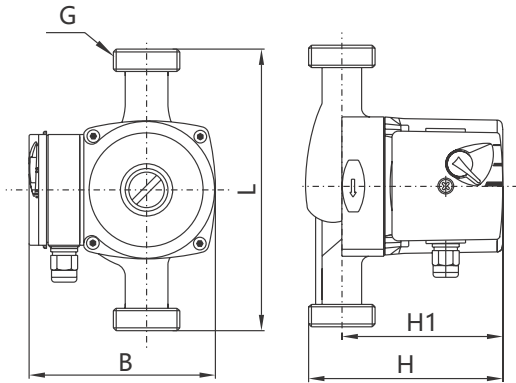

Model	Dimension					Weight(Kg)		Connection/Flange	Package size (mmxmmxmm)	
	L	H	H1	B	G	N.W.	G.W.		Inner box	Outer box
ERP20-40B/130	130	130	105	130	1"	2.1	2.4	1"-3/4"	170x140x145	350x290x300
ERP25-40B/130	130	130	105	130	1 1/2"	2.4	3	1 1/2"-1"	170x140x145	350x290x300
ERP25-40B/180	180	130	105	130	1 1/2"	2.4	3	1 1/2"-1"	200x140x145	410x290x300
ERP20-60B/130	130	130	105	130	1"	2.3	2.6	1"-3/4"	170x140x145	350x290x300
ERP25-60B/130	130	130	105	130	1 1/2"	2.6	3.2	1 1/2"-1"	170x140x145	350x290x300
ERP25-60B/180	180	130	105	130	1 1/2"	2.6	3.2	1 1/2"-1"	200x140x145	410x290x300
ERP25-80B/180	180	170	130	150	1 1/2"	4.8	5.5	1 1/2"-1"	200x165x190	410x340x195
ERP25-120B/180	180	151	128	150	1 1/2"	2.3	2.5	1 1/2"-1"	200x165x190	410x340x195

Technical Data

Model	Max. Flow (m³/h)			Max. Head (m)			Rated Power (W)			Rated Current (A)			Voltage(V)/ Frequency
	2.8	1.8	1	4	3	1.5	65	50	32	0.28	0.22	0.15	
ERP20-40B/130	2.8	1.8	1	4	3	1.5	220-240V/50Hz						
ERP25-40B/130	3.0	1.8	1	4	3	2							
ERP25-40B/180	3.0	1.8	1	4	4.5	2.5							
ERP20-60B/130	2.8	1.8	1	6	4.5	2.5	100	70	55	0.45	0.35	0.25	
ERP25-60B/130	3.3	2.5	1.3	6	4.5	2.5	245	190	135	1.1	0.85	0.60	
ERP25-60B/180	3.3	2.5	1.3	6	4.5	2.5							
ERP25-80B/180	6	4.2	2.8	8	7.5	5.5							
ERP25-120B/180	4	2.3	1.4	12	10	6	270	240	160	1.2	1.1	0.75	

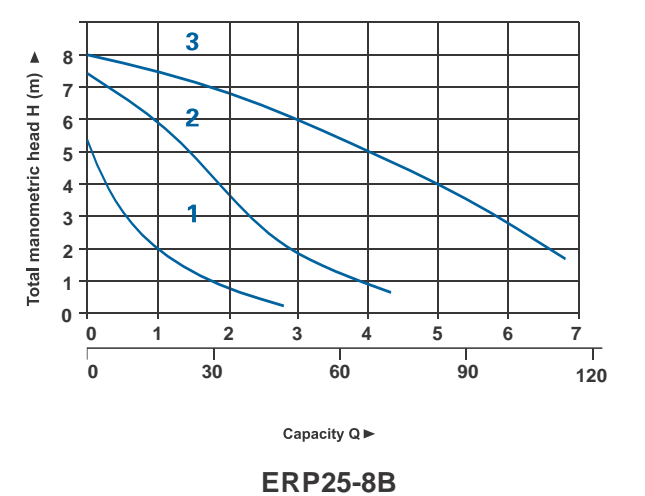
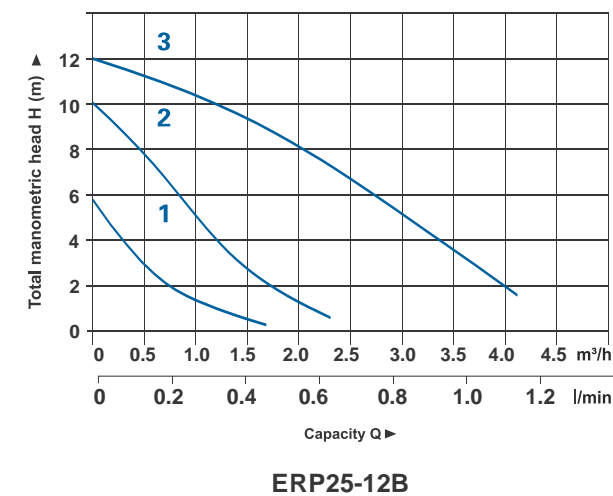
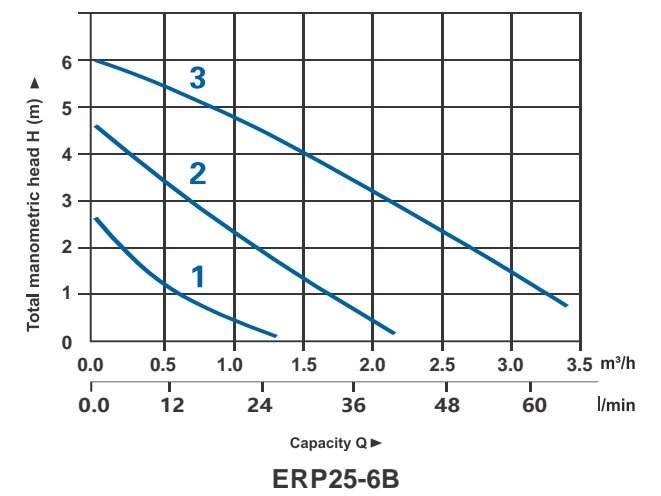
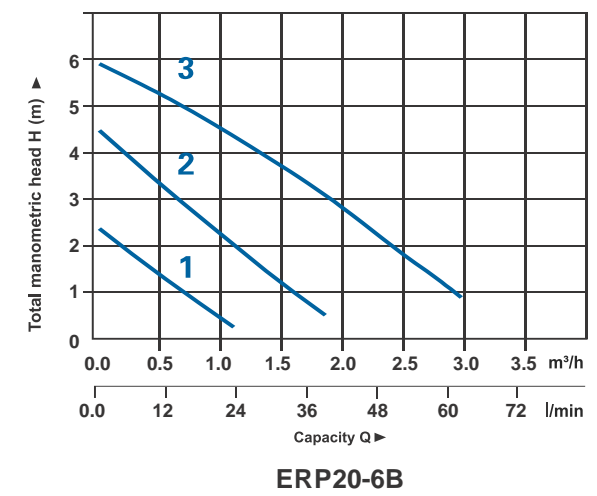
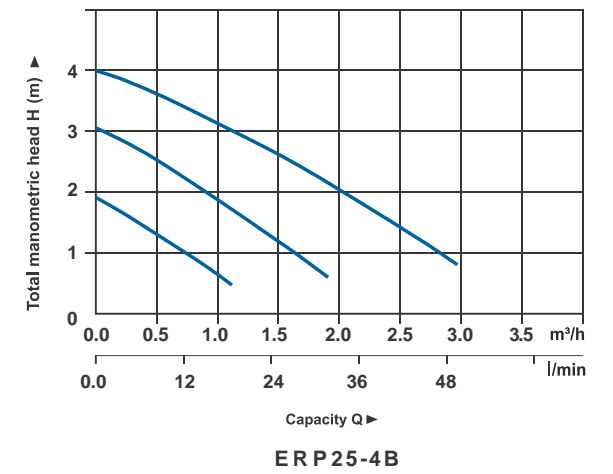
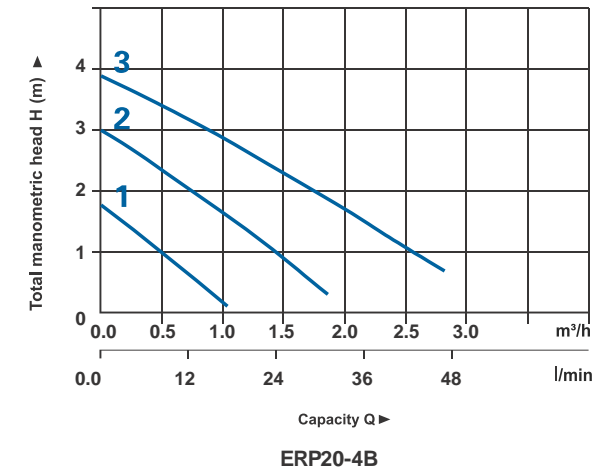



Application

- Heating systems (constant and /or variable flow)
- Air-conditioning system
- Industrial circulation system
- Domestic hot water and drinking water supply system
- Floor heating system

Working Conditions

- Liquid temperature from + 2 °C to + 110 °C
- Ambient temperature from 0 °C to + 40 °C
- Maximum system pressure ≤10 bar
- Storage: -20 °C / + 70 °C
- max. relative humidity 95% at 40 °C
- Certifications in conformity with CE requirements
- Sound pressure ≤ 43 dB(A)
- Minimum suction pressure: 0,05 bar < 85 °C 1 bar at 110 °C
- Maximum glycol quantity : 40%
- EMC according to: EN 55014-1, EN 55014-2 and EN61000-3-2,EN61000-3-3
- Connections: threaded parts ISO 228: G11/2"
- Circulator pump can consume low the power, with the EEI ≤ 0,23

Motor

- Synchronous motor with permanent magnet
- Motor : variable speed
- Standard voltage : single phase 230V (+ 6 % , -10%)
- Frequency : 50-60 Hz
- Protection : P42
- Insulation Class : H
- Class II appliance
- Cable: phases and neutral and earth
- Constructed in accordance with : EN 60335-1 = N 60335-2-51

Identification Codes

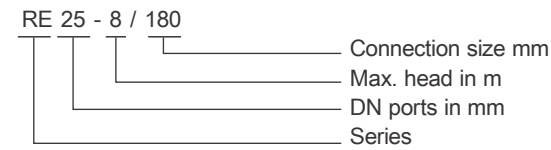

Materials Table

No.	Part	Material
1	Pump housing	Cast iron
2	Impeller	PPO
3	Bearing base	Stainless steel
4	Rotor	
5	Can brg asm	Stainless steel
6	Stator sleeve	
7	Housing	ADC12
8	Terminal box	ABS
9	PCB	
10	Terminal cover	ABS

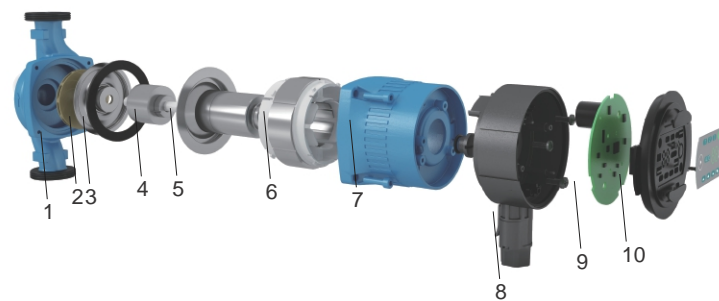

No.	Explanation
1	Electric pump automatic gearshift display(AUTO)
2	Electric pump gear shifting button
3	Electric pump proportion gear display (BL1/BL2)
4	Electric pump night mode button and display
5	Electric pump constant voltage gear display (HDI/HD2)
6	Electric pump power display
7	Electric pump constant speed display (HS1/HS2/HS3)

RE series circulating pump has 9 kinds of settings, which can be selected by buttons.

The setting of electric pump is indicated by the light lit of 9 locations:

Key position	Number of times of key	Fixed light area	Explanation
2	0	AUTO	Auto adaptation
	1,2	BL1/BL2	Proportional pressure curve
	3,4	HD1/HD2	Constant pressure curve
	5,6,7	HS1/HS2/HS3	Constant speed curve
4	Switch on/off	Night mode	Night mode curve

Factory settings= AUTO (autoadaptation mode)

Recommended and available settings of pump

Position	System type	Settings of electric pump	
		Optimal settings	Or other optional settings
A	Floor heating system	AUTO	HD1/HD2
B	Dual pipeline heating system	AUTO	BL1/BL2
C	Single pipeline heating system	BL1	BL1/BL2

- AUTO(auto adaptation)mode shall adjust the pump performance automatically according to the actual heat demand of system. Since performance is adjusted gradually, it is recommend that leave it in the AUTO (auto adaptation mode for at least a week before changing the settings of pump.
- If you choose to change back to AUTO (auto adaptation) mode , RE series pump can remember the set points of its previous AUTO mode andcontinue to adjust the performance automatically.
- Pump settings change from optimal settings to other optional settings.

Heatina system is a slow svstem , it is impossible to achieve optimal operation mode within several minutes or hours . If the optimal settings of pump fail to achieve ideal heat distribution for each room , you shouldchange the pump settings to other settings.

During the operation of pump , control it according to "proportional pressure control" (BL) principle or "constant pressure control" (HD) principle.

In these two control modes , the performance of pump and corresponding power consumption should be adjusted according to the heat demand of system.

In this control mode , the pressure difference on both ends of the electric pump remains constant , having nothing to do with flow . In Q / H figure, constant pressure curve is a level performance curve , represented by HD1 / HD2 (Section 11.3).

Installation drawing

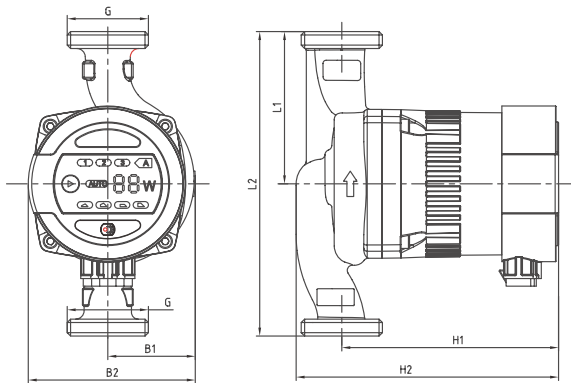

Technical Data

Power (W)	Model	Max Flow (m³/h)	Max Head (m)	Current (A)	Voltage/ Frequency	Dimensions							Package size (mmxmmxmm)			Wt.(kg)	
						L1	L2	B1	B2	H2	H1	G	Inner box	G.W.	N.W.		
22	RE20-4/130	2.3	4	0.19	220-240V/50Hz	65	130	51	98	133	153	1"	190x170x150	2.4	1.9		
	RE25-4/130	2.5				65	130	52	99	128	156	1 1/2"	190x170x150	2.9	2.1		
	RE25-4/180	2.5				90	180	52	99	128	156	1 1/2"	190x170x200	3.2	2.4		
	RE32-4/180	3.0				90	180	52	99	128	156	2"	190x170x200	3.5	2.5		
32	RE20-5/130	2.5	5	0.27		65	130	52	99	133	153	1"	190x170x150	2.4	1.9		
	RE25-5/130	3.0				65	130	52	99	128	156	1 1/2"	190x170x150	2.9	2.1		
	RE25-5/180	3.0				90	180	52	99	128	156	1 1/2"	190x170x200	3.2	2.4		
	RE32-5/180	3.5				90	180	52	99	128	156	2"	190x170x200	3.5	2.5		
45	RE20-6/130	2.8	6	0.38		65	130	52	99	133	153	1"	190x170x150	2.4	1.9		
	RE25-6/130	3.2				65	130	52	99	128	156	1 1/2"	190x170x150	2.9	2.1		
	RE25-6/180	3.2				90	180	52	99	128	156	1 1/2"	190x170x200	3.2	2.4		
	RE32-6/180	4.0				90	180	52	99	128	156	2"	190x170x200	3.5	2.5		
70	RE20-8/130	3.4	8	0.52		65	130	52	98	133	153	1"	190x170x150	2.4	1.9		
	RE25-8/130	4.0				65	130	52	99	128	156	1 1/2"	190x170x150	2.9	2.1		
	RE25-8/180	4.0				90	180	52	99	128	156	1 1/2"	190x170x200	3.2	2.4		
	RE32-8/180	5.0				90	180	52	99	128	156	2"	190x170x200	3.5	2.5		

Performance curves

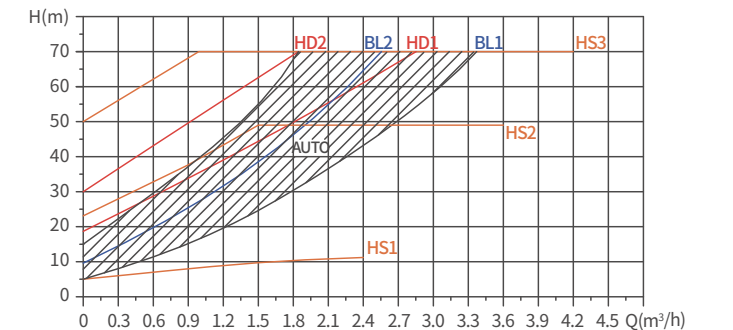
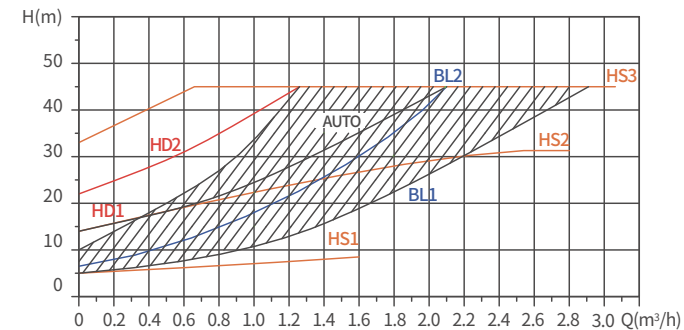
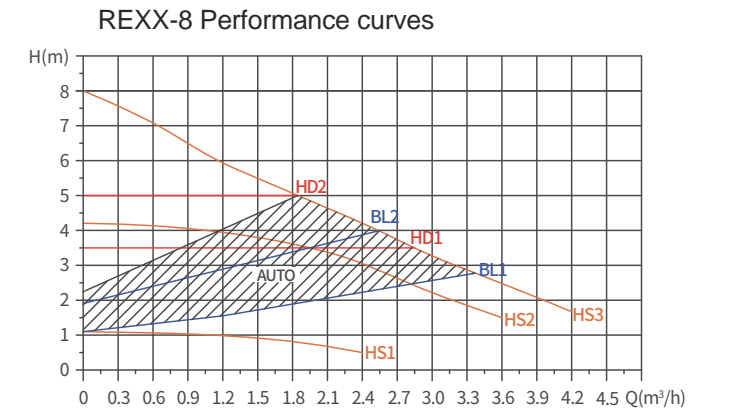
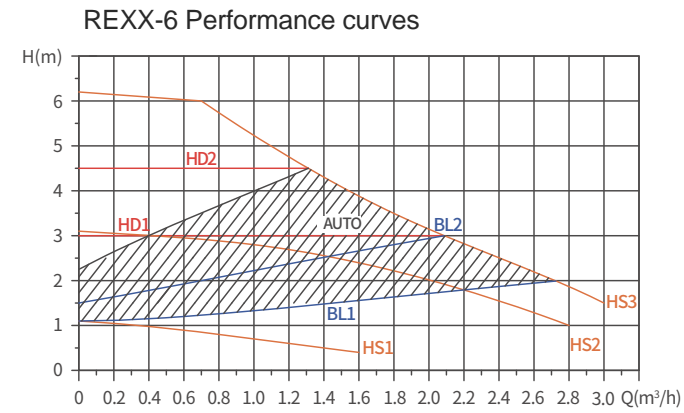
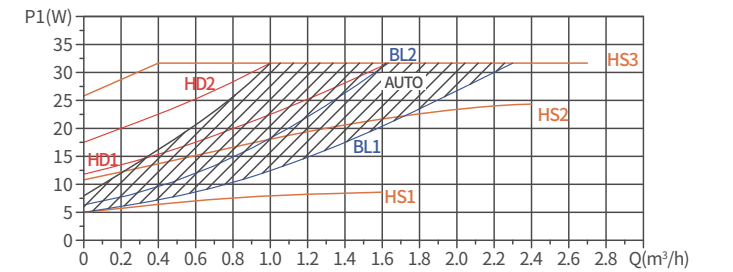
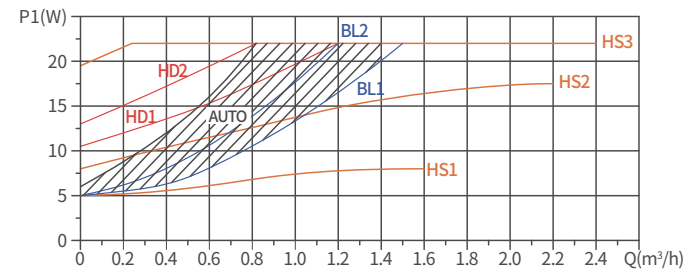
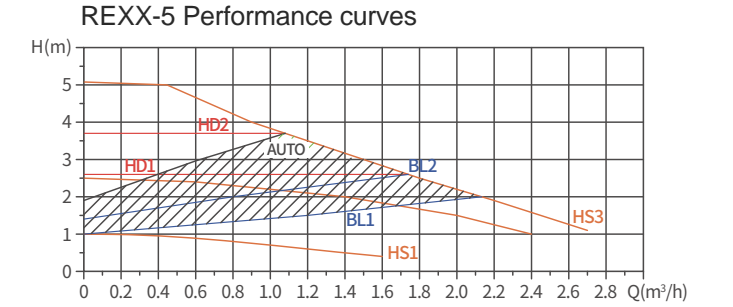
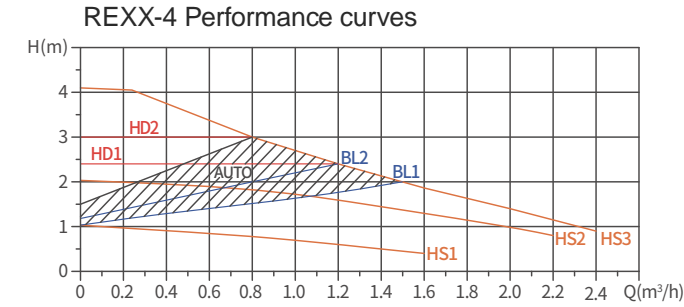



Application

- Heating systems (constant and /or variable flow)
- Air-conditioning system
- Industrial circulation system
- Domestic hot water and drinking water supply system
- Floor heating system

Working Conditions

- Liquid temperature from + 2 °C to + 110 °C
- Ambient temperature from 0 °C to + 40 °C
- Maximum system pressure ≤10 bar
- Storage: -20 °C / + 70 °C
- max. relative humidity 95% at 40 °C
- Certifications in conformity with CE requirements
- Sound pressure ≤ 43 dB(A)
- Minimum suction pressure: 0,05 bar < 85 °C 1 bar at 110 °C
- Maximum glycol quantity : 40%
- EMC according to: EN 55014-1, EN 55014-2 and EN61000-3-2, EN61000-3-3
- Connections: threaded parts ISO 228: G11/2"
- Circulator pump can consume low the power, with the EEI ≤ 0,23
- The benchmark for most efficient circulators is EEI ≤ 0,20

Identification Codes

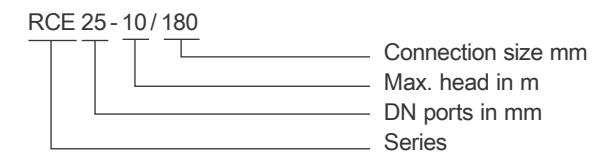

Motor

- Synchronous motor with permanent magnet
- Motor: variable speed
- Standard voltage: single phase 230 V (+6%, -10%)
- Frequency: 50-60 Hz
- Protection: IP42
- Insulation Class: H
- Class II appliance
- Cable: phases and neutral and earth
- Constructed in accordance with: EN 60335-1, EN 60335-2

Materials

No.	Name	Material
1	Pump Casing	Cast iron
2	Impeller	Composite
3	Shaft	Ceramic
4	Bearings	Carbon
5	Thrust bearing	Ceramic
6	Rotor	Composite
7	Winding	Copper wire
8	Gasket	EPDM

Control modes

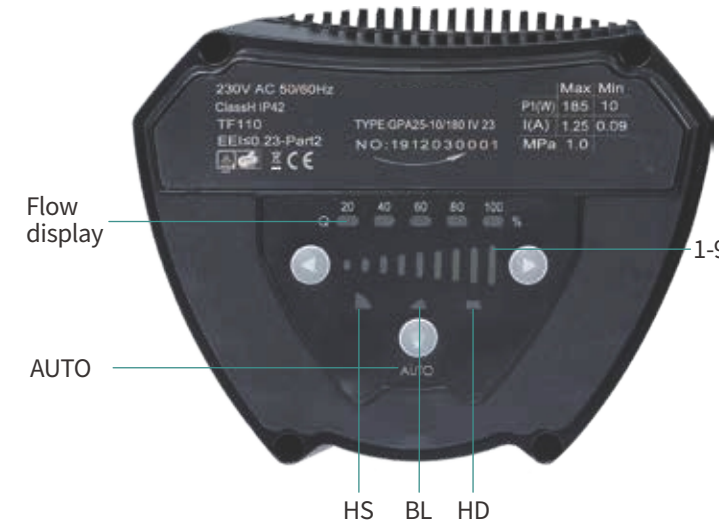

Press button to switch between different control modes and increase or decrease the setting with the buttons on left and right side.

Setting	Explanation
AUTO (factory setting)	Running within Defined Range
BL	Proportional Pressure Curve
HD	Constant Pressure Curve
HS	Constant Speed Curve

Technical data

Power supply voltage	220-240V 50/60Hz, protective earth
Motor protection	No external protection required
IP class	IP42
Insulation class	H
(RH)Humidity	Max. 95%
System pressure	1.0 MPa
Compliance	CE/ GS/ EMC/ LVD/RoHS/REACH
Environment temperature	0 ~ +40 °C
Temperature class	TF110
Liquid temperature	-30 ~ +110 °C (Glycol up to 50%)

Performance curves

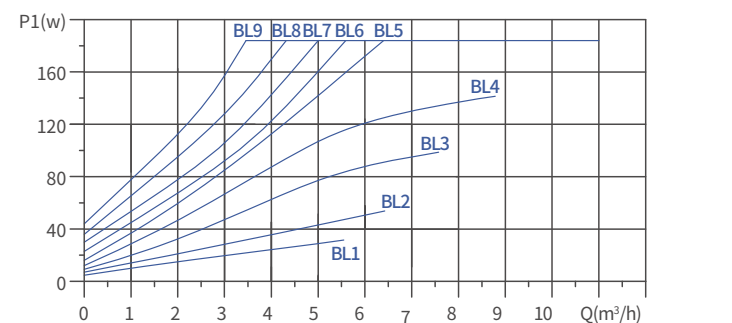
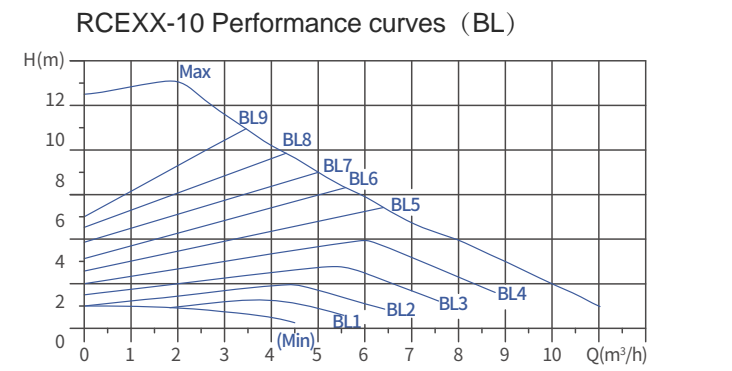
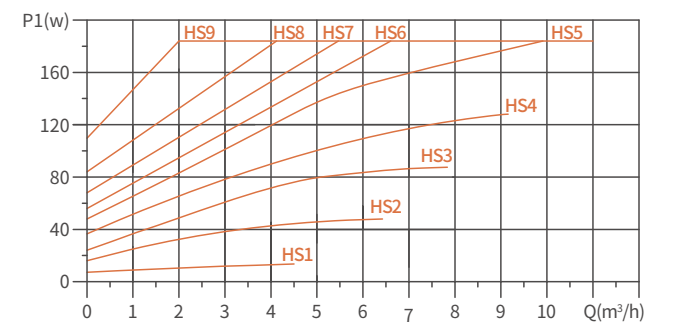
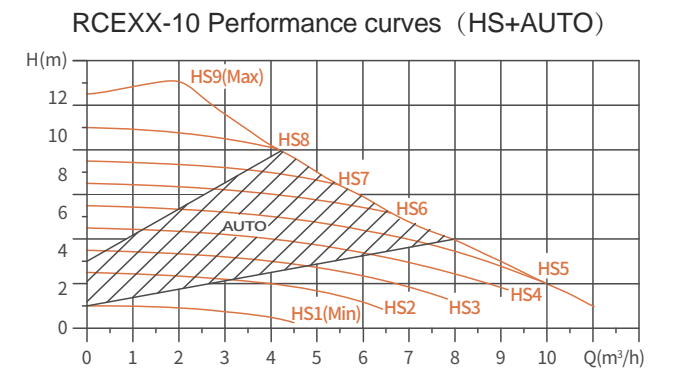
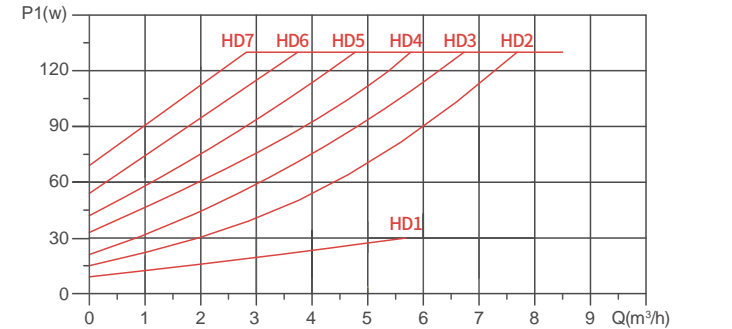
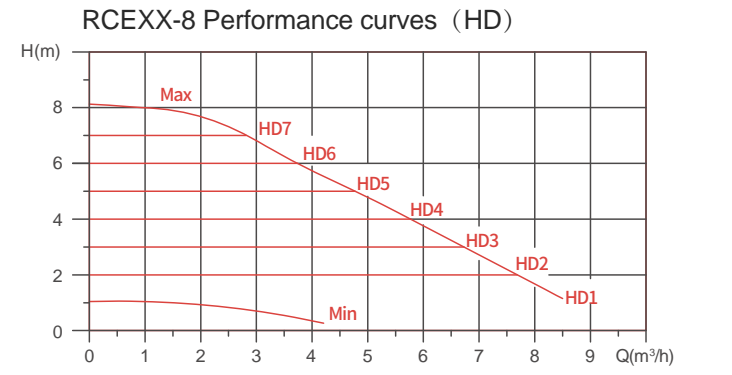
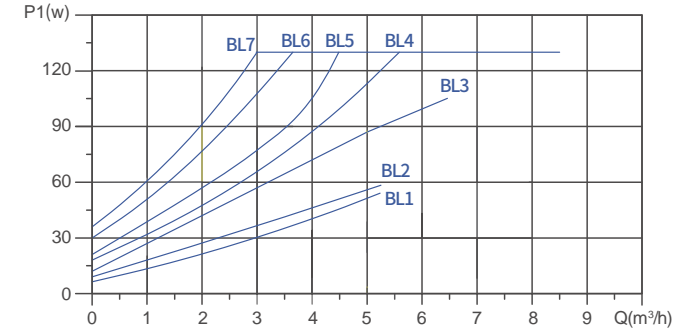
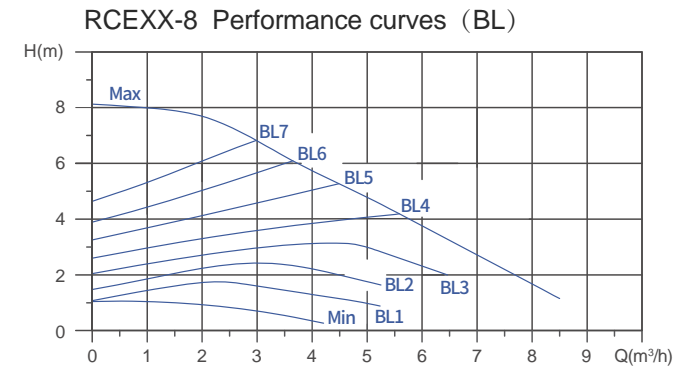
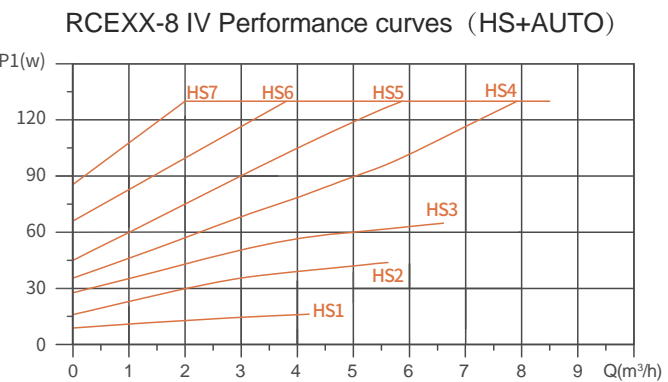
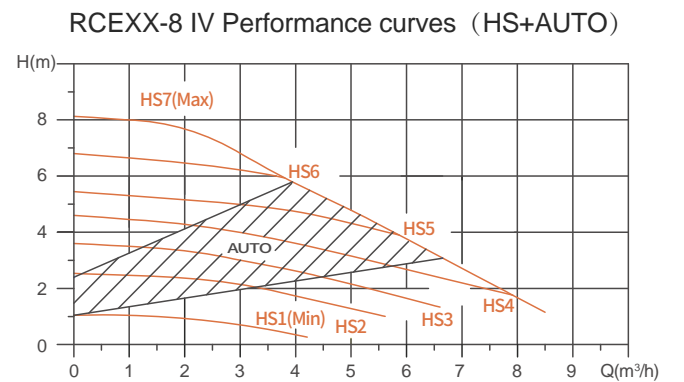
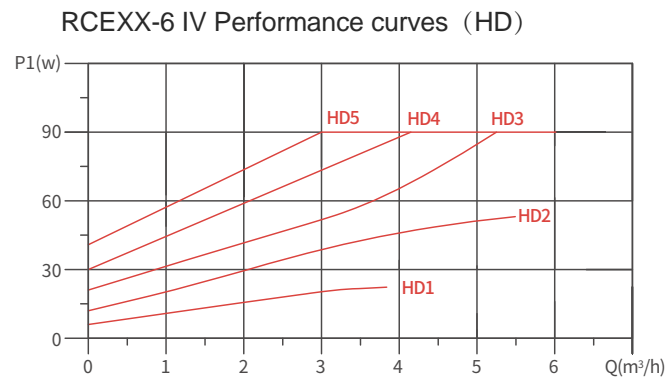
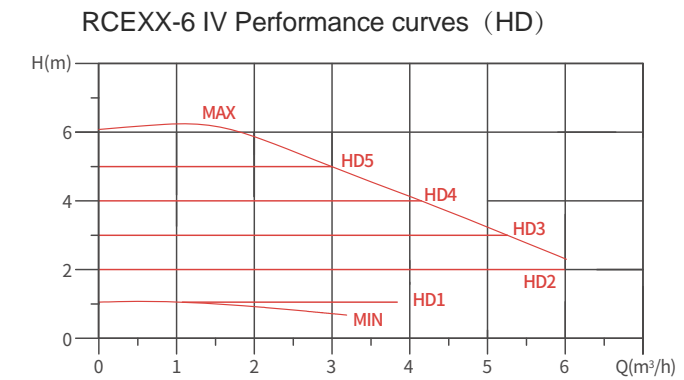
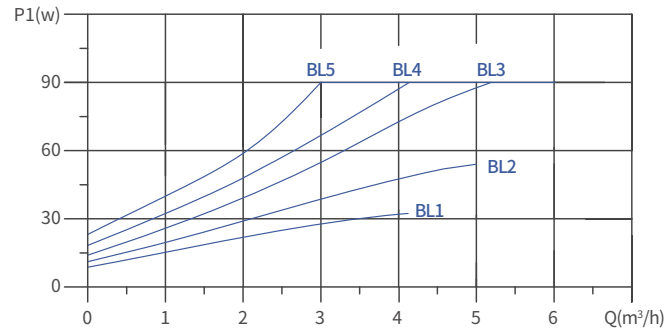
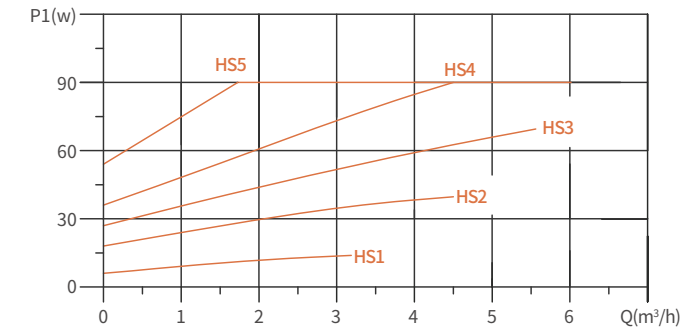
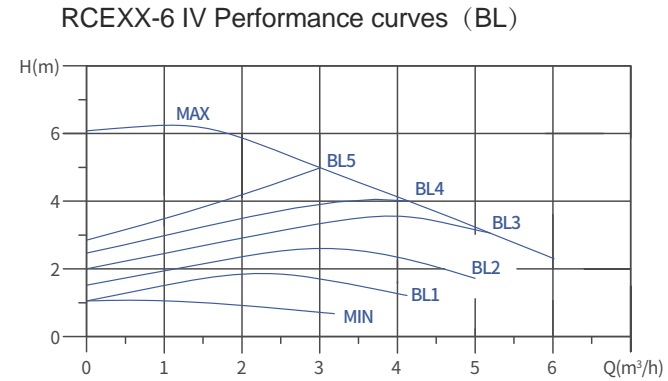
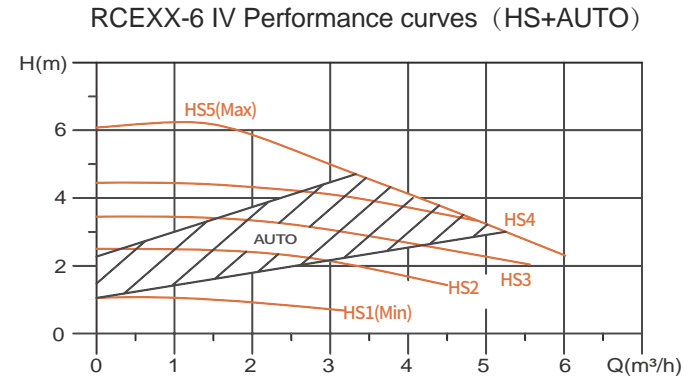

RCEXX-10 Performance curves (HD)

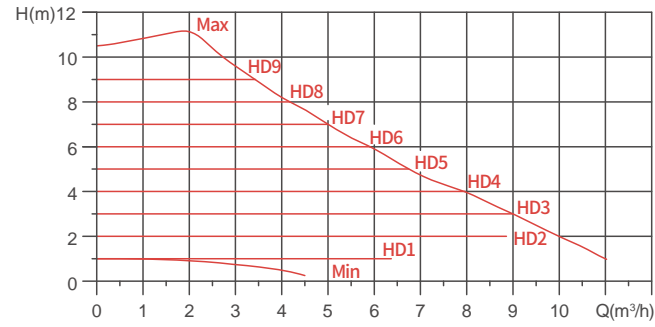

RCEXX-10 Performance curves (HD)

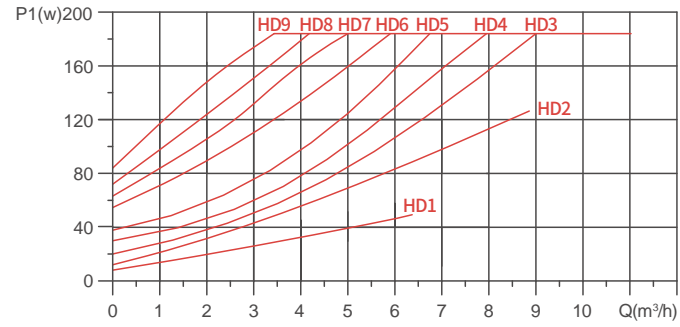

Dimension Drawing (DN/DN32)

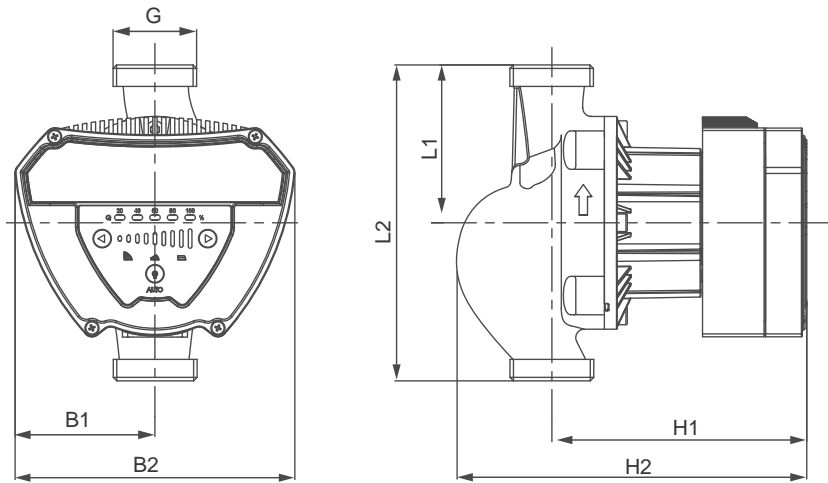

Technical Data

Model	Dimension(mm)							Package size (mmxmmxmm)		Wt.(kg)	
	L1	L2	B1	B2	H1	H2	G	Inner box	G.W.	N.W.	
RCE25-6/180	90	180	80	160	140	199	1 1/2"	235x180x200	5.0	4.5	
RCE32-6/180	90	180	80	160	140	199	2"	235x180x200	5.5	5.0	
RCE25-8/180	90	180	80	160	140	199	1 1/2"	235x180x200	5.0	4.5	
RCE32-8/180	90	180	80	160	140	199	2"	235x180x200	5.5	5.0	
RCE25-10/180	90	180	80	160	140	199	1 1/2"	235x180x200	5.0	4.5	
RCE32-10/180	90	180	80	160	140	199	2"	235x180x200	5.5	5.0	

Dimension Drawing (DN40)

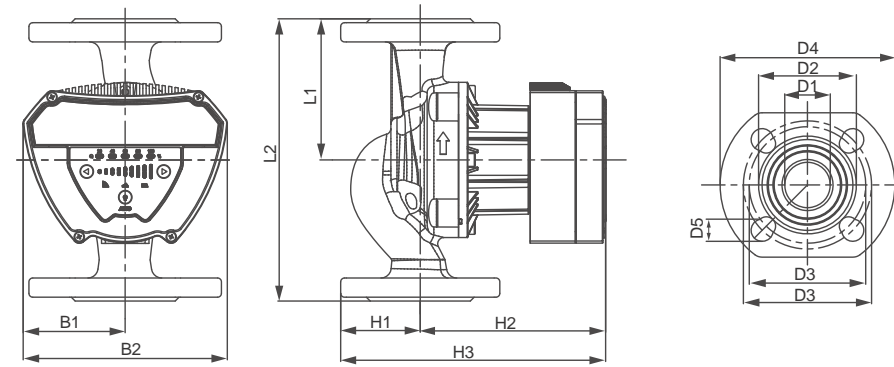

Technical Data

Model	Dimensions												Package size (mmxmmxmm)		Wt.(kg)	
	L1	L2	B1	B2	H1	H2	H3	D1	D2	D3	D4	D5	Inner box	G.W.	N.W.	
RCE40-6F/220	110	220	80	160	62	144	206	40	84	100/110	150	19	245x210x245	10.0	7.6	
RCE40-8F/220	110	220	80	160	62	144	206	40	84	100/110	150	19	245x210x245	10.0	7.6	
RCE40-10F/220	110	220	80	160	62	144	206	40	84	100/110	150	19	245x210x245	10.0	7.6	

Model	Max. Flow (m³/h)	Max Head (m)	Power(W)		Current(A)		Voltage/Frequency (V/Hz)
			Min.	Max.	Min.	Max.	
RCE25-6/180	5.5	6	6	90	0.06	0.63	230V AC 50/60Hz
RCE25-8/180	6.5	8	8	130	0.08	0.9	
RCE25-10/180	7	10	10	185	0.1	1.25	
RCE32-6/180	6.5	6	6	90	0.06	0.63	230V AC 50/60Hz
RCE32-8/180	8	8	8	130	0.08	0.9	
RCE32-10/180	10	10	10	185	0.1	1.25	
RCE40-6F/220	7.5	6	6	90	0.06	0.63	230V AC 50/60Hz
RCE40-8F/220	8.5	8	8	130	0.08	0.9	
RCE40-10F/220	10	10	10	185	0.1	1.25	



Application

- Heating systems(constant and /or variable flow)
- Air-conditioning system
- Industrial circulation system
- Domestic hot water and drinking water supply system
- Floor heating system

Working Conditions

- Liquid temperature from + 2 °C to + 110 °C
- Ambient temperature from 0 °C to + 40 °C
- Maximum system pressure ≤10 bar
- Storage: -20 °C / + 70 °C
- max. relative humidity 95% at 40 °C
- Certifications in conformity with CE requirements
- Sound pressure ≤ 43 dB(A)
- Minimum suction pressure: 0,05 bar < 85 °C 1 bar at 110 °C
- Maximum glycol quantity : 40%
- EMC according to: EN 55014-1, EN 55014-2 and EN 61000-3-2,EN61000-3-3
- Connections: threaded parts ISO 228: G11/2"
- Circulator pump can consume low the power, with the EEI ≤ 0,23
- The benchmark for most efficient circulators is EEI ≤ 0,20

Identification Codes

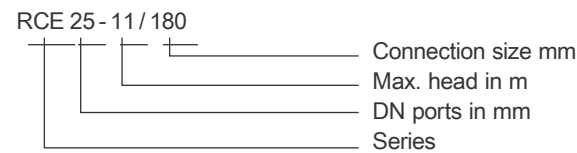

Motor

- Synchronous motor with permanent magnet
- Motor : variable speed
- Standard voltage : single phase 230V (+ 6 % , -10%)
- Frequency : 50-60 Hz
- Protection : P42
- Insulation Class : H
- Class II appliance
- Cable: phases and neutral and earth
- Constructed in accordance with : EN 60335-1 = N 60335-2-51

Materials

No.	Name	Material
1	Pump Casing	Cast iron
2	Impeller	Composite
3	Shaft	Ceramic
4	Bearings	Carbon
5	Thrust bearing	Ceramic
6	Rotor	Composite
7	Winding	Copper wire
8	Gasket	EPDM

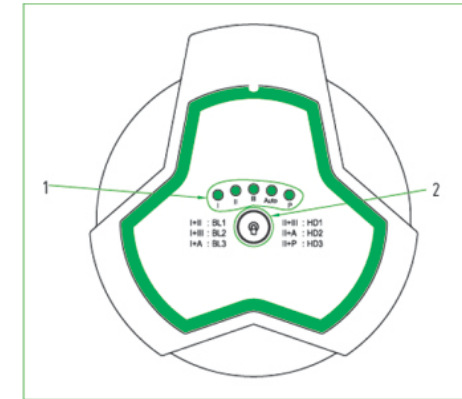

Setting	Pump characteristics curve	Functions
AUTO(Initial Setting)	Highest to Lowest proportional pressure Curve	AUTO function Will automatically control the pump performance within the specified scope -adjust pump performance based on system scale; -adjust pump performance based on load variance within a period of time; Under the AUTO mode , the pump Will be set to proportional pressure control;
BL(1-3)	Proportional pressure curve	The operating point of the pump will move up and down on the lowest proportional pressure curve based on the demand of system flow rate.when flow demand decreases , the pressure supply of pump drops; when flow demand increases , the pressure supply of pump rises .
HD(1-3)	Constant pressure curve	The operation point of the pump will move around the constant pressure curve based on the demand of system flow rate . The head (pressure) is kept constant , regardless of the flow request.
HS(1-3)	Constant speed curve	It runs on the constant curve in a constant velocity under the Velocity HS (1-3) mode ,the pump is set to work on the highest curve under all working conditions . Set under HS3 mode in a short time ,fast venting can be arranged on the pump.
Q (0-100%)	Flow Display	Indicating the flow percentage when pump is running

RCE series circulation pumps have 11 kinds of settings , pressing the button to choose . 5 different light area indicating all the settings;

Lighting area	Description	Graphical representation
AUTO (factory reset)	Auto adaptation	<input type="radio"/> I <input type="radio"/> II <input type="radio"/> III <input checked="" type="radio"/> Auto <input type="radio"/> P
HS1	Constant speed low speed	<input checked="" type="radio"/> I <input type="radio"/> II <input type="radio"/> III <input type="radio"/> Auto <input type="radio"/> P
HS2	Constant speed medium speed	<input type="radio"/> I <input checked="" type="radio"/> II <input type="radio"/> III <input type="radio"/> Auto <input type="radio"/> P
HS3	Constant speed high speed	<input type="radio"/> I <input type="radio"/> II <input checked="" type="radio"/> III <input type="radio"/> Auto <input type="radio"/> P
BL1	Proportional pressure low speed	<input checked="" type="radio"/> I <input checked="" type="radio"/> II <input type="radio"/> III <input type="radio"/> Auto <input type="radio"/> P
BL2	Proportional pressure medium speed	<input checked="" type="radio"/> I <input type="radio"/> II <input checked="" type="radio"/> III <input type="radio"/> Auto <input type="radio"/> P
BL3	Proportional pressure high speed	<input checked="" type="radio"/> I <input type="radio"/> II <input type="radio"/> III <input checked="" type="radio"/> Auto <input type="radio"/> P
HD1	Constant pressure low speed	<input type="radio"/> I <input checked="" type="radio"/> II <input checked="" type="radio"/> III <input type="radio"/> Auto <input type="radio"/> P
HD2	Constant pressure medium speed	<input type="radio"/> I <input checked="" type="radio"/> II <input type="radio"/> III <input checked="" type="radio"/> Auto <input type="radio"/> P
HD3	Constant pressure high speed	<input type="radio"/> I <input checked="" type="radio"/> II <input type="radio"/> III <input type="radio"/> Auto <input checked="" type="radio"/> P
P	PWM control	<input type="radio"/> I <input type="radio"/> II <input type="radio"/> III <input type="radio"/> Auto <input checked="" type="radio"/> P

Initial setting= AUTO (Self-adaptive mode)

Recommended and available motor pump setting

Position	System type	Motor Pump Setting	
		Recommended	Options
A	Floor heating system	AUTO	HD(1-3)
B	Dual pipeline heating system	AUTO	BL(1-3)
C	Single pipeline heating system	BL1	BL(1-3)

- AUTO (Self Adaptive Mode) mode can adjust the performance of motor pump based on the actual heat demand of the system . As the performance is adjust edgradually , it is suggested , before changing motor pump setting , to maintain AUTO (Automatically Adaptive Mode) mode setting for at least one week.
- If you select to changeback to auto (Self adaptive Mode) mode , the RCE series motor pump can memorize its last setting in AUTO mode and continue adjusting the performance automatically.
- It may take several minute so reven hours to reach the optimal operation mode after motor pump setting is changed from the optimal setting (the Recommended above mention) to other optional setting . If the optimal setting of motor pump fails to enable each room to obtain desired heat distribution , then you should change the motor pump setting to other settings.
- Please refer to Section 10.1 for the relations between motor pump setting and performance curve.

When the motor pump is working , the motor pump is controlled according to the principle of “proportional Pressure Control (BL)” or “Constant Pressure Control (HD)”.

In these two control modes , the motor pump performance and corresponding power consumption will be regulated according to the heat demand of the system.

Proportional Pressure Control

In this control mode, the differential pressure of both ends of the motor pump will be controlled by the flow rate. In the Q/H Figure, proportional pressure curve is represented with BL(1-3). Please refer to Section 11.3.

Constant Pressure Control

In this control mode , the differential pressure of both ends of the motor pump remains constant and is irrelevant to the flow rate . In the Q / H Figure, constant pressure curve is a horizontal performance curve represented with HD (1-3) . Please refer to Section 11.3.

Installation drawing

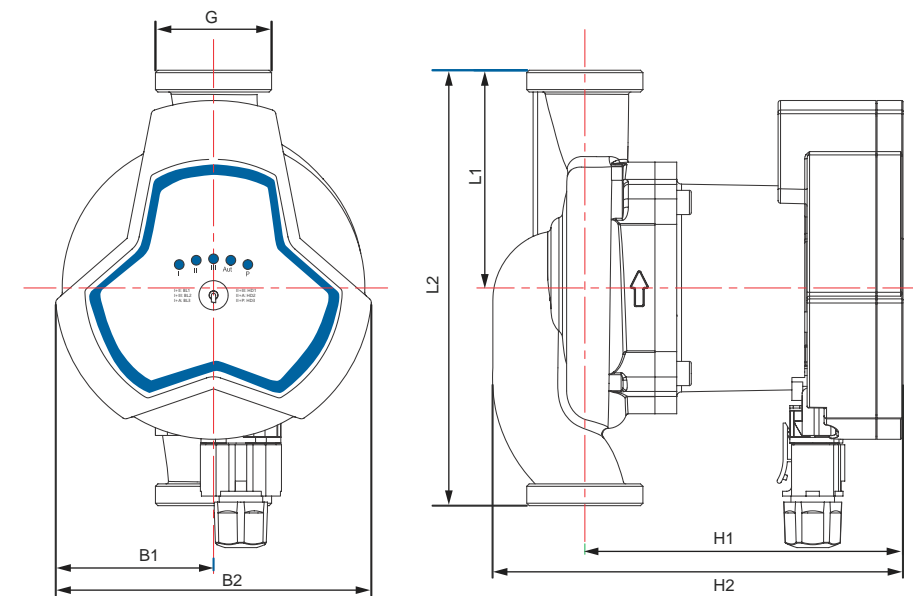

Technical Data

Model	Power (W)	Dimension(mm)						
		L1	L2	B1	B2	H1	H2	G
RCE 25-11/180	140	90	180	66	132	132	170	1 1/2"
RCE 32-11/180	140	90	180	66	132	132	170	1 "

Performance curves

Constant Speed & AUTO Mode Performance Curve

RCE 25-11 Series Performance Chart (Constant Speed+Auto Mode)

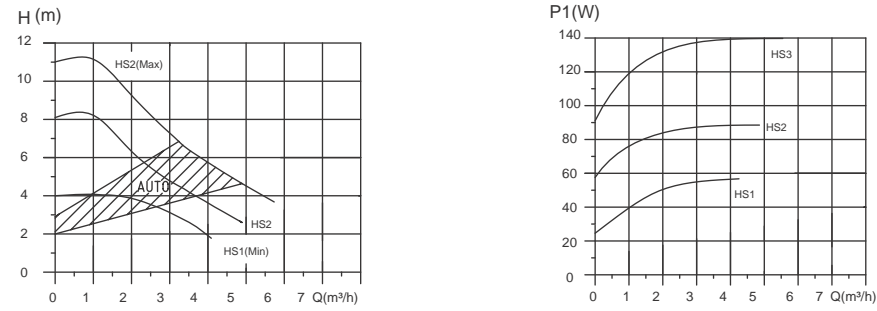

Constant Speed & AUTO Mode Performance Curve

RCE 32-11 Series Performance Chart (Constant Speed+Auto Mode)

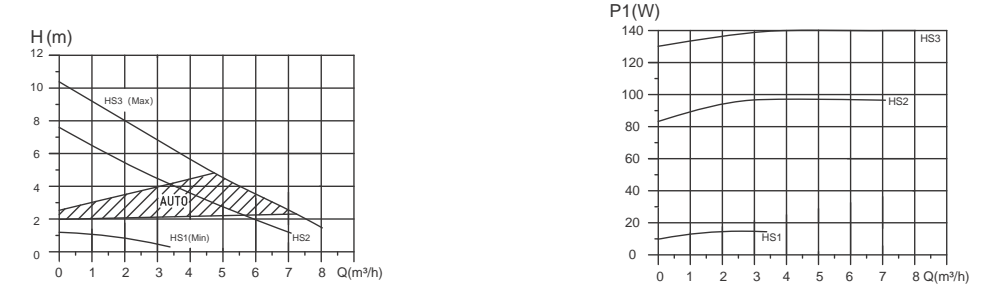

Constant Pressure Mode Performance Curve

RCE 25-11 Series Performance Chart (Constant Pressure)

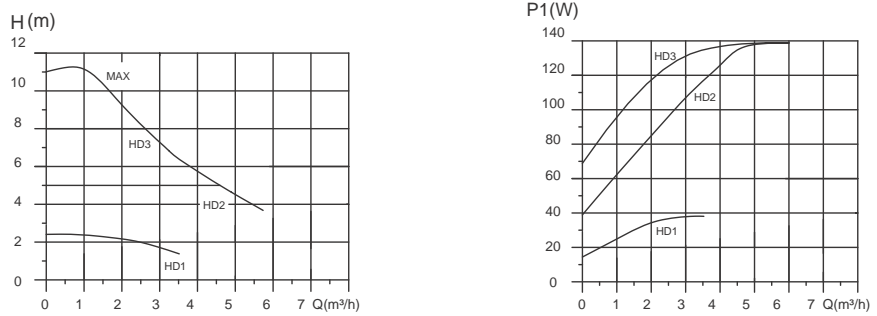

Proportional Pressure Performance Curve

RCE 32-11 Series Performance Chart (BL Mode)

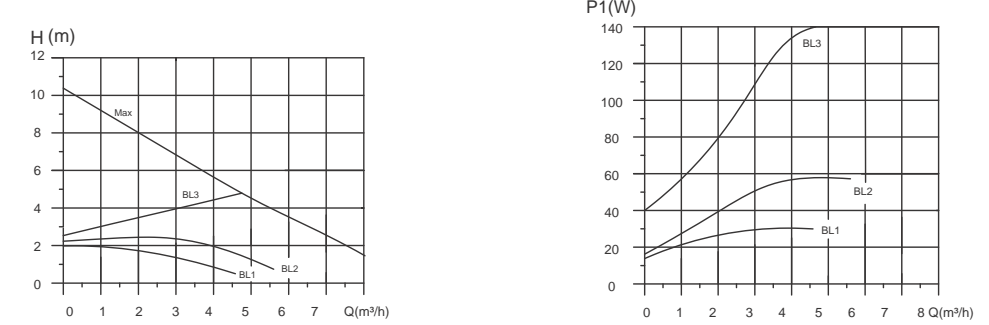

Proportional Pressure Performance Curve

RCE 25-11 Series Performance Chart (BL Mode)

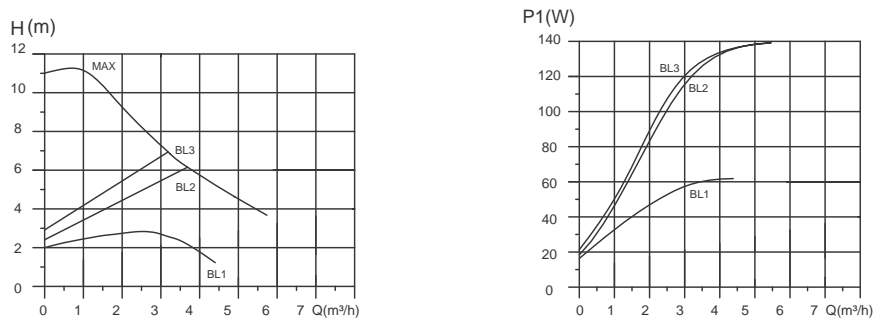

Constant Pressure Mode Performance Curve

RCE 32-11 Series Performance Chart (Constant Pressure)

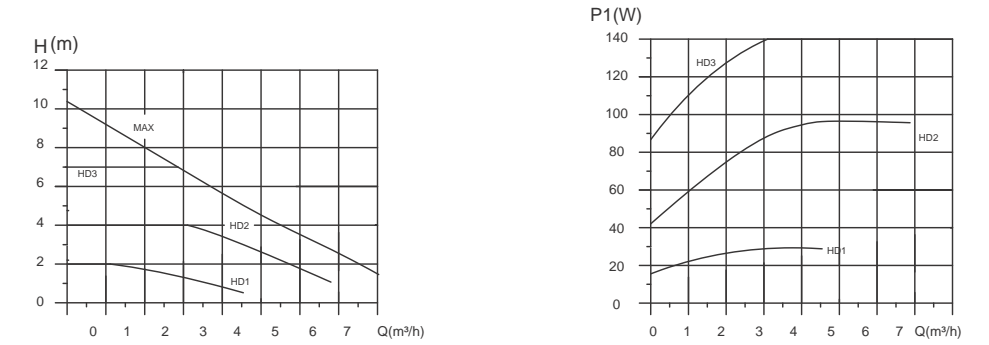

PWM Mode Performance Curve

RCE 25-11 Series Performance Chart (PWM)

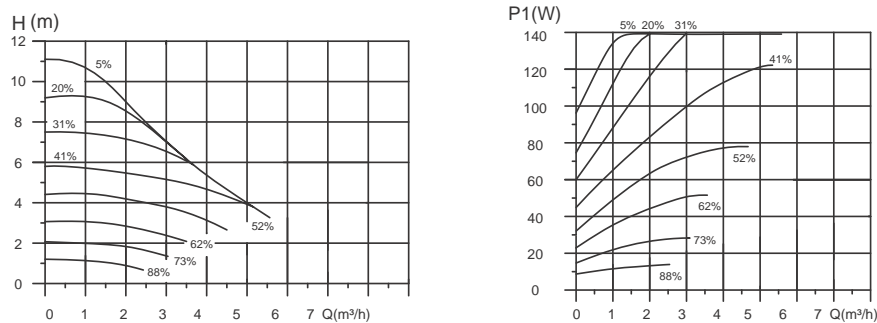

PWM Mode Performance Curve

RCE 32-11 Series Performance Chart (PWM)

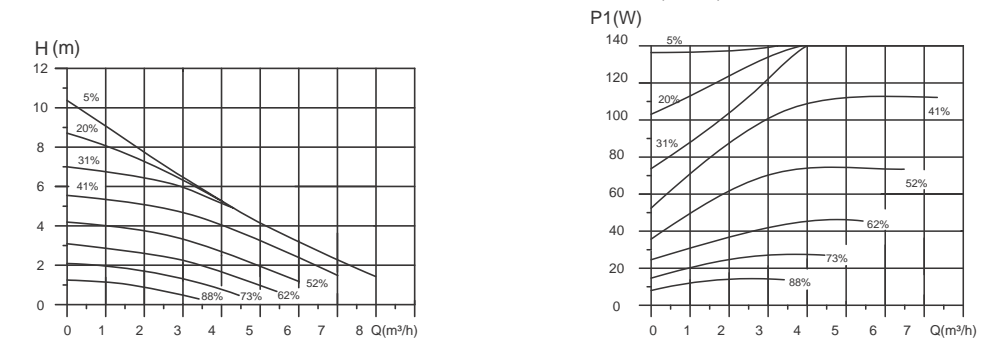

Application

- Clear water or other liquid similar to water in physical and chemical properties
- Pressure boosting or circulating for domestic water supply
- Water treatment system

Pump

- Automatic pressure boosting with flow sensor
- Liquid temperature: 0 ~ 40°C
- Brass impeller and pump body
- Max. system pressure: 6 bar
- Stainless steel pump shaft

Motor

- Integrated stamping stainless steel motor shell
- Copper winding
- Protection class: IP44
- Insulation class: B

Identification Codes

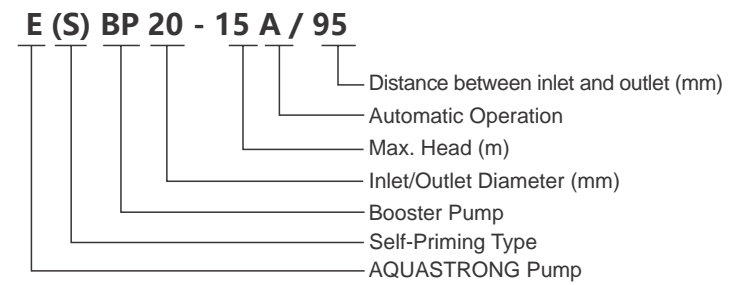

Technical Data

Model	Power (W)	Voltage (V)	Frequency (Hz)	Connection Size (G)	Speed (r/min)	Highest Head (m)	Rated Head (m)	Max. Capacity (L/min)	Rated Capacity (L/min)	G.W. (Kg)
EBP20-15A/105	120	110/220	50/60	3/4"	2860	15	10	25	13	4.0
EBP25-15A/125	120	110/220	50/60	1"	2860	15	10	30	15	4.2
ESBP20-15A/95	120	110/220	50/60	3/4"	2860	15	10	25	13	4.5

Performance Curves

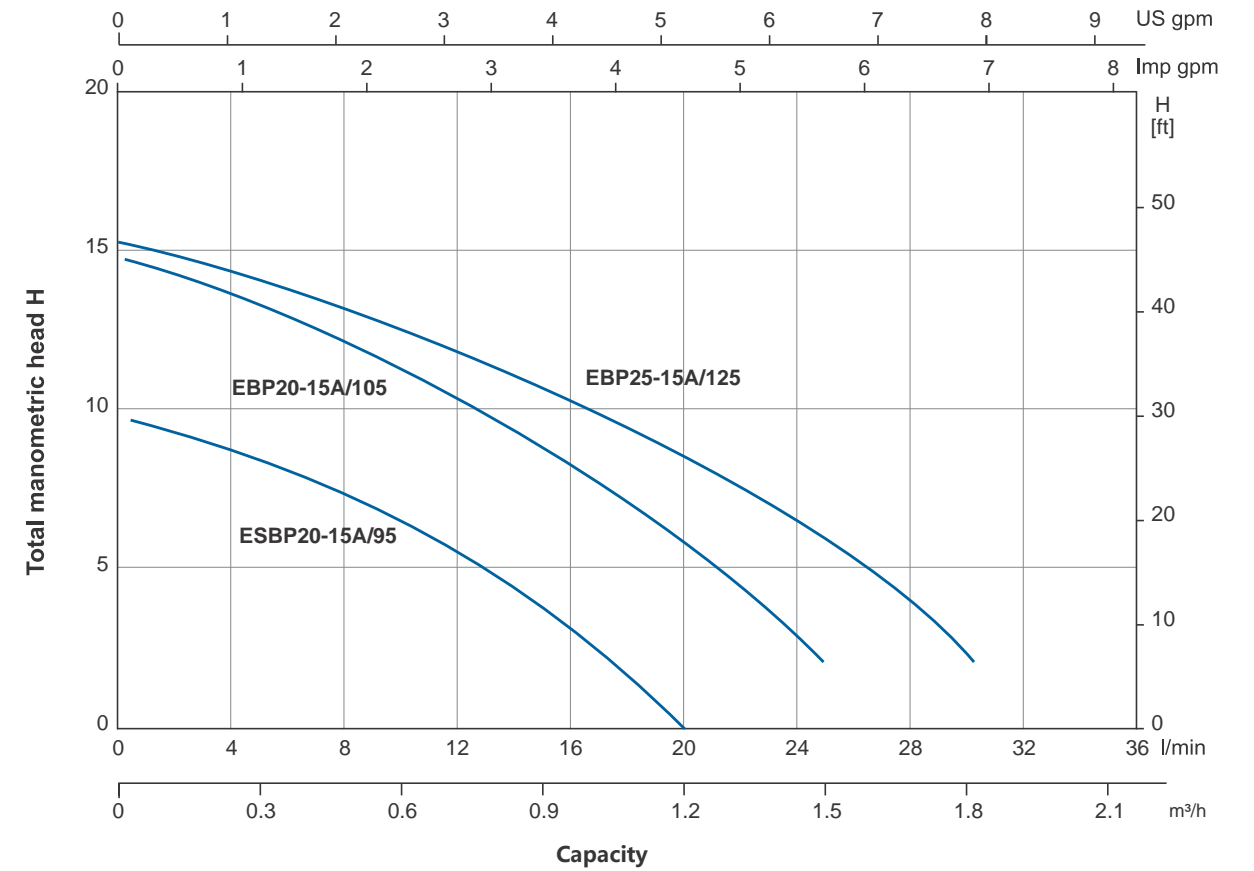

Dimension Drawing

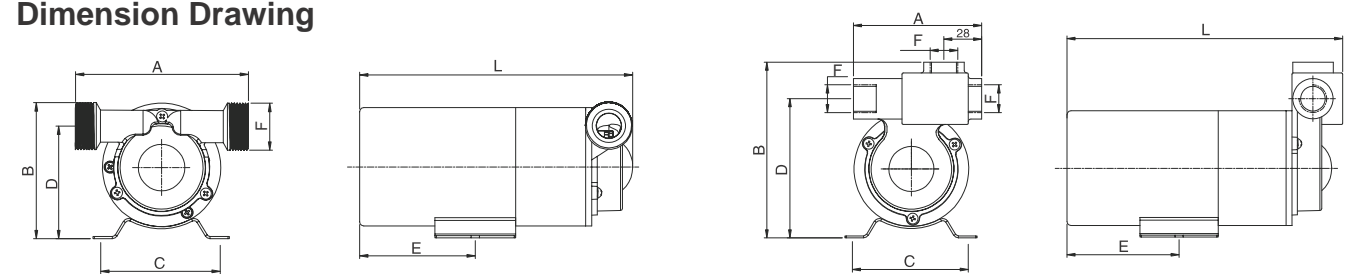

Model	A	B	C	D	E	L	F
EBP20-15A/105	105	95	81	82	83	196	3/4"
EBP25-15A/125	125	95	81	79	83	196	1"
ESBP20-15A/95	95	130	81	103	83	205	3/4"



Application

It is widely used for

- Pressure boosting for domestic water supply
- Floor heating system
- Solar pumping system

Pump

- Automatic pressure boosting
- Anti-rust cast iron pump body
- Noryl impeller with heat resistance up to 150 °C
- 99% alumina ceramic shaft
- Liquid temperature: 2 °C - 60 °C

Motor

- Insulation class: H
- Protection class: IP42
- 99% alumina ceramic braring
- Copper winding

Dimension Drawing

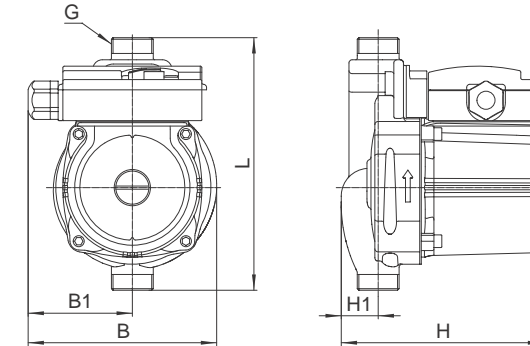

Model	L (mm)	B (mm)	B1 (mm)	H (mm)	H1 (mm)	G
ERP15-90A/160	160	120	70	130	25	G3/4

Technical Data

Model	Voltage/Frequency	Power (W)	Max.Flow (l/min)	Max.Head (m)	N.W. (kgs)	G.W. (kgs)	Packing Size (mm)
ERP15-90A/160	1~230V/50Hz	120	25	9	2.72	2.74	198x143x160

Performance Curves

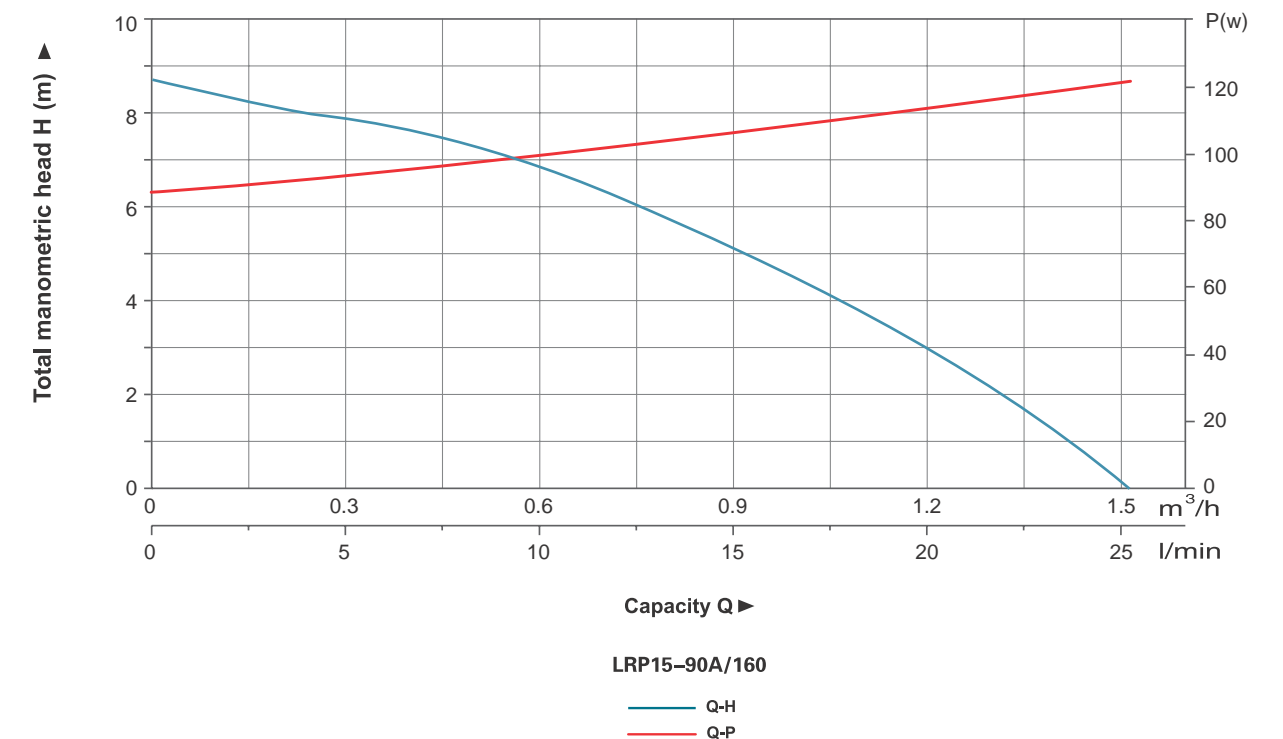

Connectors on request



Identification Codes

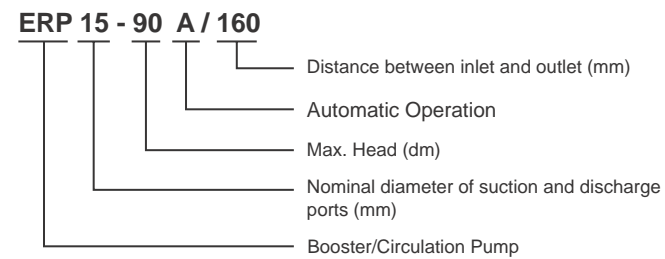

Materials Table

No.	Part	Material
1	Rotor	
2	Thrust bearing adjusting mat	Noryl
3	Thrust ring support	Silicon rubber
4	Bushings	Graphite
5	Front bearing	Alumina
6	Pump support cover	Stainless steel
7	Check ball	Silicon rubber
8	Impeller	PPO
9	Pump body	Cast iron/bronze
10	Pump body insert	Stainless steel
11	Body gasket	
12	Rear bearing	HT200
13	Can brg asm	Stainless steel
14	Can brg asm seal	Silicon rubber
15	Stator cover(front)	PA66
16	Stator sleeve	
17	Stator cover(back)	PA66
18	Housing	ADC12
19	Cable outlet nut	ABS
20	Button	ABS
21	Terminal box	PA6
22	Regulation switch	
23	Capacitor	
24	Terminal cover	ABS
25	Flow switch assembly	

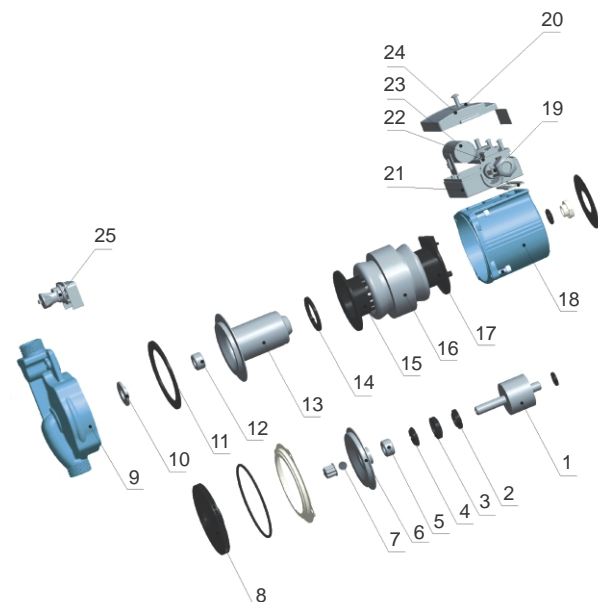

Applications

- It is suitable for boosting hot water powered by solar energy for sauna and bathing and solves insufficient water pressure in high-rise buildings.
- It can also supply water (less than 100°C) to two families.

Pump

- Cast iron pump body and support under special anti-rust treatment
- AISI 304 shaft
- Liquid temperature: 2°C - 100°C

Motor

- Insulation class: F
- Protection class: IP44

Identification Codes

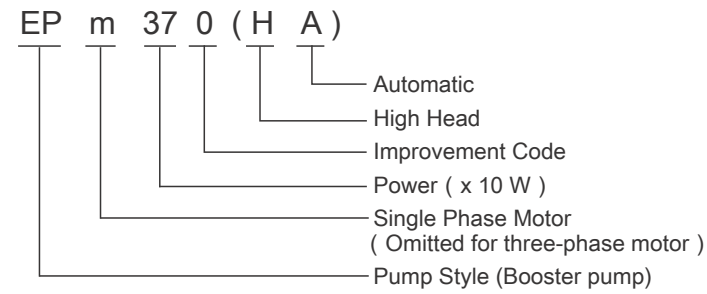

Materials Table

EPm125/EPm250/EPm370/EPm550

No.	Part	Material
1	Flange	HT200
2	Pump body	HT200
3	Flange gasket	
4	Impeller	PPO
5	Machanical seal	Carbon/Ceramic
6	O ring	
7	Support	HT200
8	Bearing	
9	Rotor	
10	Stator	
11	Terminal box	ABS
12	Capacitor	
13	Terminal box cover	
14	Rear cover	ZL102
15	Fan	PP
16	Fan cover	08F

EPm370HA/EPm750HA

No.	Part	Material
1	Pump body	HT200
2	Impeller	PPO
3	O ring	
4	Support	HT200
5	Bearing	
6	Rotor	
7	Machanical eel	Carbon/Ceramic
8	Control switch	
9	Stator	
10	Terminal box Capacitor	ABS
11	Terminal box cover	
12	Rear cover	
13	Fan	ZL102
14	Fan cover	PP
15	Fan	08F
16	Fan cover	08F

Dimension Drawing

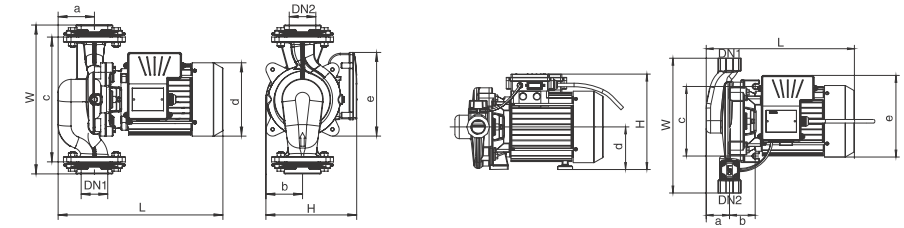

Model	DN1	DN2	L (mm)	W (mm)	H (mm)	a (mm)	b (mm)	c (mm)	d (mm)	e (mm)
EPm125	1 1/2"	1 1/2"	275	260	186	47	74	210	Φ141	160
EPm250	2"	2"	301	313	190	71	78	260	Φ141	164
EPm370	2 1/2"	2 1/2"	367	334	195	77	84	280	Φ141	173
EPm550	2"	2"	369	344	210	81	87	280	Φ165	182
EPm370HA	1"	1"	295	270	209	43	60	124	Φ95	141
EPm750HA	1"	1"	341	310	220	54	59	160	Φ98	165

Technical Data

Model	Power kW	Q(m³/h) Q(l/min)	0	1.5	3	4.5	6	7.5	9	10.5	12	13.5	15	16.5	18	19.5
			0	25	50	75	100	125	150	175	200	225	250	275	300	325
EPm125	0.125	H (m)	5.5	5	4.8	3.8	3	1.7	-	-	-	-	-	-	-	-
EPm250	0.25		5.5	5.2	5.1	4.9	4.6	4.2	3.5	2.8	2	-	-	-	-	-
EPm370	0.37		8	7.9	7.8	7.5	7.2	6.7	6.2	5.6	4.8	4	3.3	2.3	-	-
EPm550	0.55		19	19	18.9	18	17	16	14.9	13.7	12.4	11.2	9.8	8.5	6.6	4

Model	Power kW	Q(m³/h) Q(l/min)	0	0.6	1.2	1.8	2.4	3.0	3.6	4.2	4.8	5.4	6.0	6.6
			0	10	20	30	40	50	60	70	80	90	100	110
EPm370HA	0.37	H (m)	21	20.6	18.5	16	13.4	10	5.5	-	-	-	-	-
EPm750HA	0.75		30.8	30.7	30	29.5	28.3	26.3	24.4	22	19	16.2	13.2	9.4

Performance curves

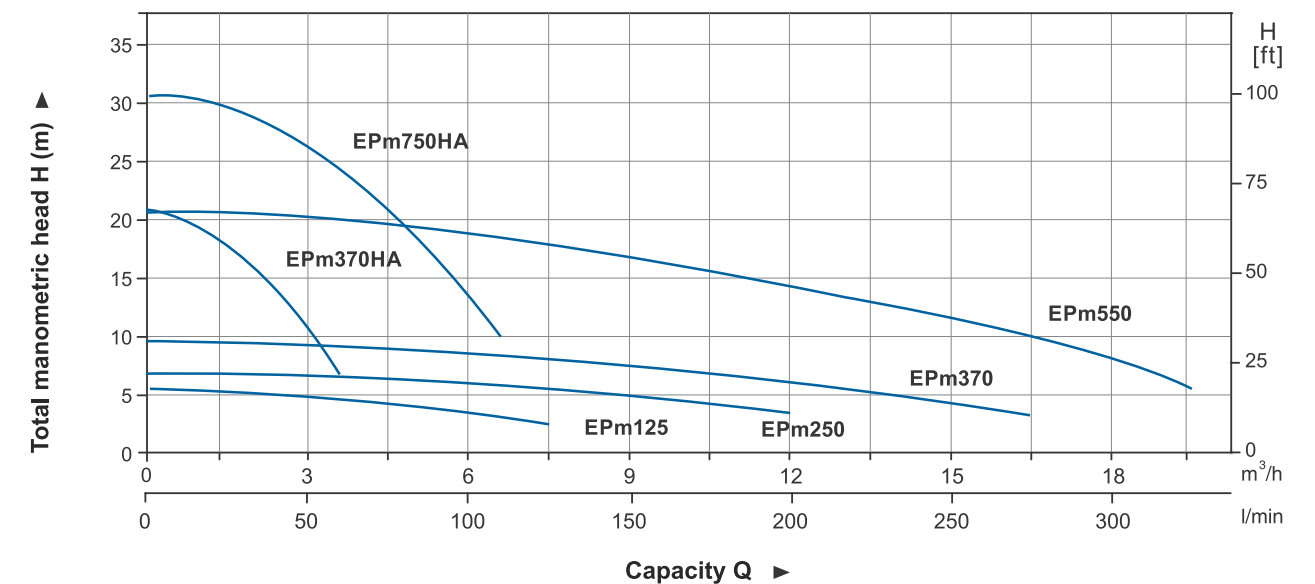



Three-phase



Single-phase

Applications

- Hot water circulation and heating system
- Air-conditioning system
- Industrial circulation system
- General pressure boosting in household

Pump

- Cast iron pump body and support under special anti-rust treatment
- AISI 304 shaft
- Liquid temperature: 2°C - 100°C

Motor

- Insulation class: B
- Protection class: IP44

Identification Codes

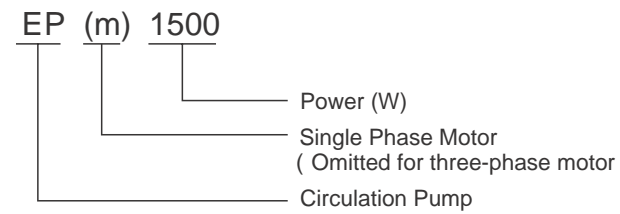

Materials Table

No.	Part	Material
1	Flange	HT200
2	Pump body	HT200
3	Impeller	Brass
4	Support	HT200
5	Bearing	
6	Rotor	
7	Fan cover	08F
8	Fan	PP
9	Terminal box	ABS
10	Rear cover	ZL102
11	Stator	ABS
12	Capacitor	

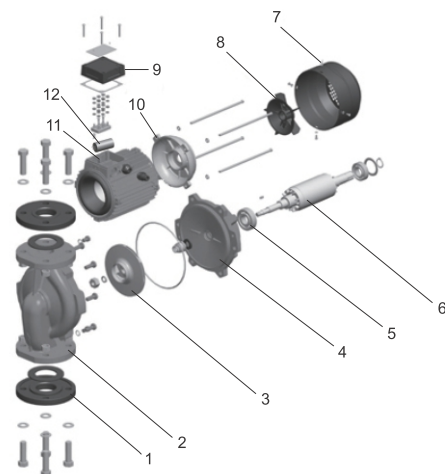

Dimension Drawing

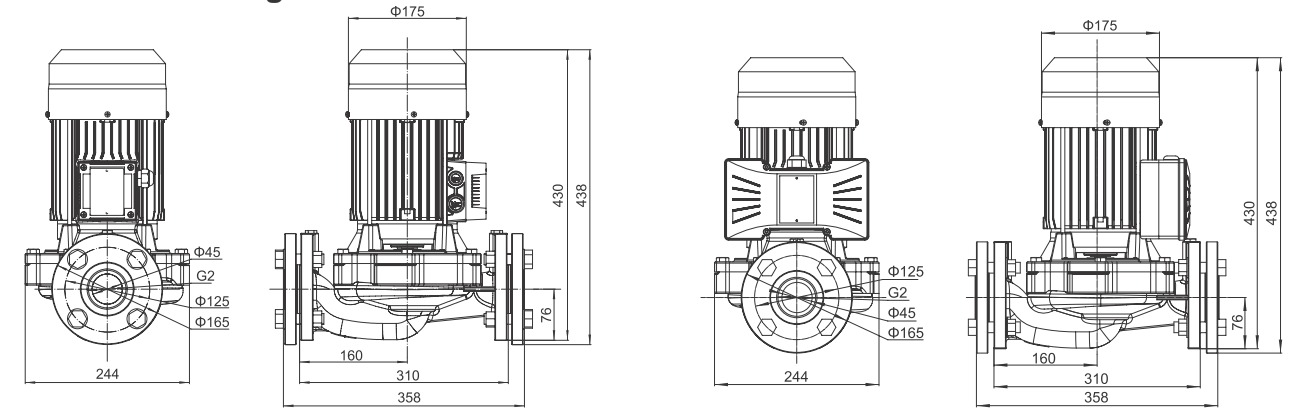

Three-phase

Single-phase

Model	G.W (kg)	L (mm)	W (mm)	H (mm)
EP(m)1500	37	450	325	375
EP(m)2200	38.8	450	325	375

Technical Data

Model	Power		Q(m³/h) Q(l/min)	0	6	9	12	15	18	21	24	30	32
	kW	HP		0	100	150	200	250	300	350	400	500	533
EP(m)1500	1.2	2	H	36	25	24	23	21	19	17	13	5	0
EP(m)2200	2.2	3	(m)	34	33	32	30	28	26	23	20	12	8

Performance curves

